



USER'S MANUAL

TRIPLE OUTPUT DC POWER SUPPLY

ARRAY 3631A

ARRAY ELECTRONIC

ARRAY 3631A

TRIPLE OUTPUT DC POWER SUPPLY

The ARRAY 3631A is a 80W triple output DC power supply. It is easy to control from the front panel, or with industry standard SCPI commands via the USB, RS232 or GPIB. The low noise, excellent regulation, and built-in voltmeter/ammeter make this reliable power supply the right choice for many applications. It provides quiet, stable DC power for both manual and automatic testing, in R&D and in manufacturing environments.

Versatile bench-top features

- * 0~+6V/0~5A, 0~±25V/0~1A triple output
- * Highly visible vacuum-fluorescent display
- * Keyboard and knobs with all functions
- * Symmetrical tracking operation for ±25V output
- * Excellent line and load regulation
- * Low ripple and noise
- * Up to 10 operating states can be stored for later recall
- * Portable, ruggedized case with non-skid feet

Flexible system features

- * Standardized USB, RS-232 and GPIB(Optional) interfaces
- * SCPI(Standard Commands for Programmable Instruments) compatibility
- * Direct setting of I/O Parameters from front-panel

The Front panel at a glance

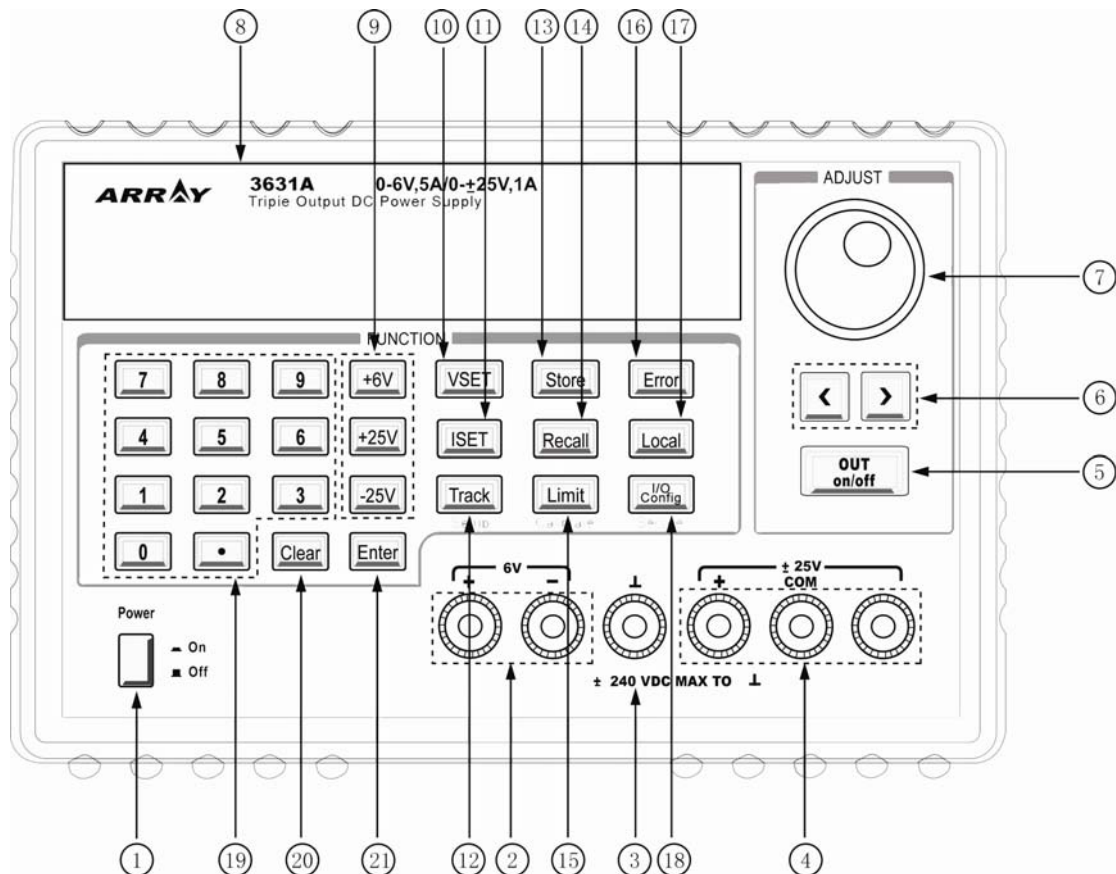

- | | |
|---------------------------------------|----------------------------------|
| 1. AC power switch | 2. +6V supply output terminals |
| 3. Earth ground terminal | 4. ±25V supply output terminals |
| 5. Output on/off key | 6. Left/Right key |
| 7. Control knob | 8. Display |
| 9. +6V/+25V/-25V output selection key | 10. Voltage setting key |
| 11. Current setting key | 12. Tracking enable/disable key |
| 13. Store key | 14. Recall key |
| 15. Limit value setting/calibrate key | 16. Error key |
| 17. Local key | 18. I/O configuration/secure key |
| 19. Number key | 20. Clear key |
| 21. Enter key | |

1. **AC power switch:** used to turn the AC power on and off.
2. **+6V supply output terminals:** +6V power supply output, the positive pole is in red, the negative pole is in black.
3. **Earth ground terminal:** which is connected to the chassis and earth ground through a 3-wire ground receptacle.
4. **$\pm 25V$ supply output terminal:** $\pm 25V$ supply output, +25V output is in red, the common is in black, -25V output is in green.
5. **Output on/off key:** turn the power supply on/off.
6. **Left/Right key:** Move the blinking digit to left or right, or select different options.
7. **Control knob:** Adjust the value of the blinking digit or select different options by turning clockwise or counter clockwise.
8. **Display:** Show the parameters and status of the power supply.
9. **+6V/+25V/-25V output selection key:** Select one power output to be monitored on front panel.
10. **Voltage setting key (VSET):** Displays or modifies the present voltage setting value.
11. **Current setting key (ISET):** Displays or modifies the present current setting value.
12. **Tracking enable / disable key (Track):** Enables /disables the track mode of $\pm 25V$ supplies.
13. **Store key (Store):** Stores the present operating states in location "0", "1", "9".
14. **Recall key (Recall):** Recalls a previously stored operating state from location: "0", "1", "2", "9".

15. **Limit value setting/calibrate key (Limit/Calibrate):** Setting the maximum of voltage limit value and current limit value; or enables calibration mode (the power supply must be unsecured before performing calibration).
16. **Error key (Error):** Queries or reads the error codes.
17. **Local key(Local):** Returns the power supply to local mode from remote interface mode.
18. **I/O config/secure key (I/O config):** Configures the power supply for remote interfaces, or secure and unsecure the power supply for calibration.
19. **Number key (0-9 and .):** Set the value of the specified function.
20. **Clear key (Clear):** Clears present input value or exits current operation.
21. **Enter key (Enter):** Confirms present setting values or option.

Display Annunciators

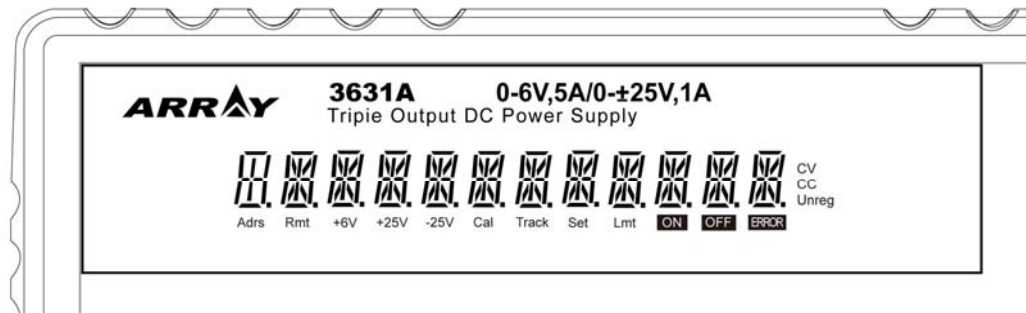

Adrs	Power supply is addressed to listen or talk over a remote interface.
Rmt	Power supply is in remote interface controlling mode.
+6V	Displays the output for +6V supply state.
+25V	Displays the output for +25V supply state.
- 25V	Displays the output for -25V supply state.
CAL	Power supply is in calibration mode.
Track	The outputs of +25V and -25V supplies are in track mode.
Set	The power supply is in settings of output voltages and output current.
Limit	The display shows the voltage and current upper limit value of the power supply.
On	The output of power supply is ON.
Off	The output of power supply is OFF.
ERROR	Hardware or remote interface command errors are detected and also the error bit has not been cleared or read.
Unreg	The output is unregulated (output is neither CV nor CC).
CV	The output of power supply is in constant-voltage mode.
CC	The output of power supply is in constant-current mode.

The rear panel at a glance

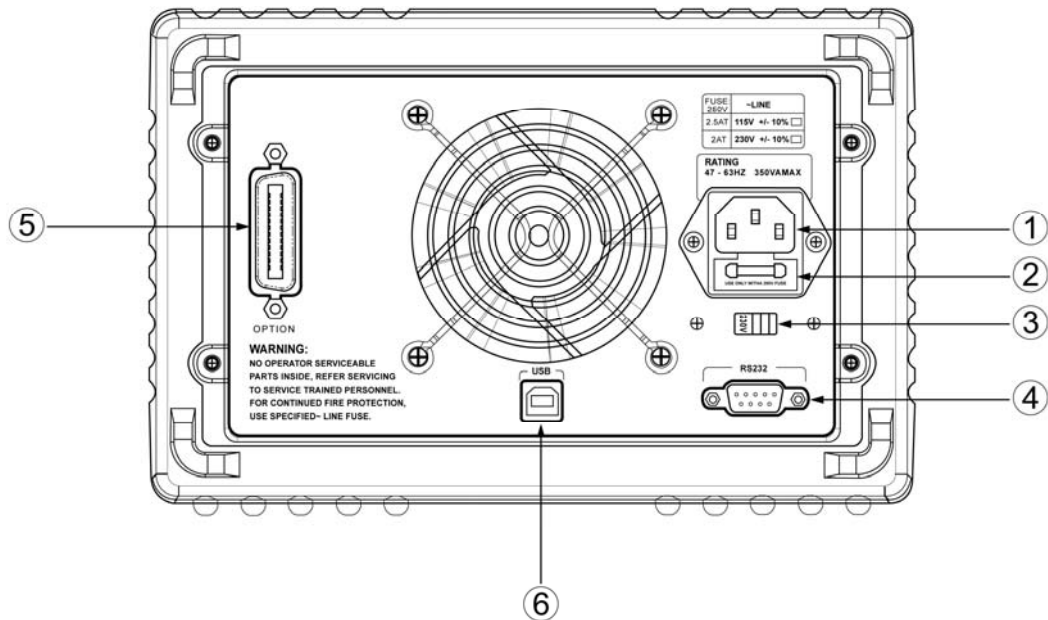

-
- | | |
|---------------------------------------|-------------------------------|
| 1. AC inlet | 2. Fuse holder |
| 3. AC power-line voltage switch | 4. RS-232 interface connector |
| 5. GPIB interface connector(optional) | 6. USB interface connector |

Use "I/O CONFIG" key on front panel to:

- * Select the RS-232, USB or GPIB interface.
- * Select the RS-232 baud rate, parity, number of data bits and flow control mode.
- * Set the GPIB bus address.

General Information

Apart from a general description of your power supply, it provides instructions for checking your power supply, selecting power-line voltage and connecting to ac power.

Initial Operation

To ensure that the power supply develops its rated outputs and responds to operation from the front panel properly.

Front-Panel Operation

To describe the use of front-panel keys and knobs in detail and how to use them to operate the power supply from the front panel. And also shows how to configure the power supply for the remote interface and introduce the calibration features in brief.

Remote Interface Reference

The reference information contained could help you program the power supply over the remote interface, and also introduces how to program for status reporting.

Application Programs

It provides some remote interface applications to help you develop programs for your application.

Tutorial

It describes basic operation of linear power supplies and gives specific details on the related operation and use of the ARRAY 3631A power supplies.

Specifications

It lists the power supply's each basic specifications.

Contents

Chapter 1	General Information.....	12
	Safety Considerations.....	12
	Description.....	12
	Installations.....	14
	Initial Inspections.....	14
Chapter 2	Initial Operations.....	16
	Preliminary checkout.....	17
	Power line cord.....	17
	Power-line voltage selection.....	17
	Power-on checkout.....	20
	Output checkout.....	21
	Voltage output checkout.....	22
	Current output checkout.....	23
Chapter 3	Front panel operations.....	26
	Set limit value of voltage/current.....	29
	Constant voltage output setting.....	31
	Constant current output Setting.....	33
	Adjusting output voltage.....	36
	Adjusting output current.....	37
	Setting $\pm 25V$ tracking mode.....	39
	Storing and recalling operating state.....	40
	Enabling/Disabling the outputs.....	43
	System-Related operations	44
	Self-test.....	44
	Error information.....	45
	Display controlling	46
	SCPI language version query.....	47
	Firmware version query.....	48
	Remote interface configuration.....	48
	RS-232 interface configuration.....	49
	RS-232 interface configuration overview.....	49
	RS-232 data frame format.....	50
	Connection to a computer or a terminal.....	50
	DTR/DSR handshake protocol.....	51

Baud rate selection.....	52
Parity selection.....	53
Flow control selection.....	53
To set the Baud rate and parity	54
RS-232 troubleshooting.....	55
Set USB interface.....	56
Set GPIB interface.....	57
The power supply calibration.....	59
Calibration password	60
To unsecure for Calibration.....	60
Calibration.....	65
Calibration security.....	71
Change the security Code.....	72
Restore the default calibration parameters	73
Initialize/Initiate calibration parameters.....	74
 Chapter 4 Remote interface references.....	 77
SCPI command summary.....	78
An Introduction to the SCPI Language.....	79
Simplified programming overview.....	87
Using APPLY command.....	87
Using low-level commands.....	88
Selecting a trigger source.....	89
Programming ranges and output identifiers.....	89
Using APPLY command.....	90
Output setting and operation commands.....	91
Output selection commands.....	92
Measurement commands.....	94
Output on/off and tracking operation commands.....	95
Output setting commands.....	95
Trigger source Choice.....	99
Selection a trigger source	99
Triggering commands.....	100
System related commands.....	101
Calibration commands.....	104
RS-232 interface commands.....	106
SCPI status register.....	107
What is an event register?.....	107
What is an enable register?.....	107
What is a multiple logical output?.....	108
Status reporting commands.....	109

SCPI conformance information.....	117
SCPI confirmed commands.....	118
Device Specific Commands.....	119
Chapter 5 Application programs.....	122
Chapter 6 Tutorial.....	125
Overview of ARRAY 3631A operation.....	125
Output characteristics.....	126
Unregulated state.....	128
Unwanted signals.....	128
Connecting the load.....	128
Output isolation.....	128
Multiple loads.....	129
Considerations.....	130
Extending the output.....	131
Reliability	132
Chapter 7 Technical specifications.....	134
Performance Specifications.....	134
Supplemental characteristics.....	136
APPENDIX Error Messages.....	140
Execution errors.....	141
Self-test errors.....	145
Calibration errors.....	145

1

----- **General information**

General information

This chapter provides a general description of your power supply. And it also contains instructions related to initial inspection, selecting the power-line voltage, and connecting your power supply to AC power.

Safe considerations

This power supply is a Safty Class I instrument provided with a protective earth terminal. The terminal must be connected to earth ground through a power source with a 3-wire ground receptacle when being connected to AC power supply.

Before installation or operation, please check the power supply and read safety markings and instructions introduced in this manual first. Please see relevant chapters to see related specific information about safety operations.

Description

The ARRAY 3631A is a programmable linear regulated DC power supply. The excellent line and load regulation, extremely low ripple and noise make it well suited as a high preference power system. The triple power supply delivers 0 to ± 25 V outputs rated at 0 to 1 A and isolated 0 to +6 V output rated at 0 to 5 A. The ± 25 V power supplies also provide tracking mode to supply operational amplifier and power-amplifying circuit which require symmetrically balanced voltage. Tracking precision is $\pm(0.2\% \text{ output} + 20 \text{ mV})$. The ± 25 V power supplies can also be used in series as a single 0~50V/1A power supply.

Each output voltage or current can be adjusted independently from front panel, or controlled over RS-232, USB, or GPIB interface. Buttons and knobs on the front panel can be used to adjust voltage and current selected; enable or disable tracking mode of ± 25 V output; store or transfer 10 sets of working status of power supply used frequently, enable or disable the output of triple power supply; calibrate again without opening out the case when the precision falls down (including change password for calibration); switch the power supply from remote

controlling mode to local mode; set and monitor the power supply over remote interface; monitor the setting and output of power supply via vacuum-fluorescent display, and all the status indication, error information appeared during working.

When being controlled over remote interface, it can be used both as a listener and a speaker at the same time. The power supply can be set and data can be returned over RS-232, USB, or GPIB interface by external controller. The following functions can be performed through RS-232, USB, or GPIB interface:

- * Voltage and current programming
- * Voltage and current readback
- * Enable or disable track mode
- * Store/recall working status
- * Programming syntax error detection
- * Calibration
- * Output ON/OFF
- * System self-test

This power supply is equipped with a vacuum-fluorescent display for displaying the output of voltage and current. A 4-digit voltage and a 4-digit current could show the actual or setting value of a selected supply simultaneously. At any time, the three output selection keys can switch the displayed value to the output voltage and current of any one supply to be monitored.

binding terminals on the front panel. The +25V and -25V supply's outputs share a common output terminal which is isolated from chassis ground.

The positive and negative terminals of each output can be grounded, or kept a certain voltage with the chassis ground. But voltage between each output and the chassis ground should be kept within ± 240 Vdc. The power supply is provided with a detachable, 3-wire grounding type power cord. The AC line fuse is on the rear panel. It can be extracted for replacement when needed.

The power supply can be calibrated from the front panel directly or with a controller over the GPIB or RS-232 interface without opening the cabinet. Correction factors are stored in non-volatile memory. You can guard against unauthorized calibration by using the "Standard" calibration protection function.

Installation

Initial inspection

When you receive your power supply, please check it for any obvious damage that may have occurred during shipment or resulted from other reasons. If any damage is found, contact the carrier and the Sales Office immediately in order to deal with it in time.

Keep the original packing materials in case the power supply has to be returned to Array for repairing in the future. If you return the power supply for service, please attach a tag identifying the owner and model number. A brief description of the malfunction also needs to be included.

Mechanical Check

This check confirms that there are no broken keys or knob, and that the cabinet and panel surfaces are free from dents and scratches, and that the display is not scratched or cracked as well.

Electrical Check

Please see Chapter 2 for an initial operation procedure. When successfully completed, it can be convinced that the power supply is operating in accordance with its specifications.

Temperature control

The power supply's performance will not be affected when operating within the temperature range of 0 °C to 40 °C, and output current may fall down from 40 °C to 55 °C. A DC brushless fan is used to cool the power supply by drawing cool air through the rear panel and exhausting it with heat out the sides.

Sufficient space must be left at the rear and two sides of the cabinet for air circulation when installing the power supply. Please remove the rubber bumpers for rack mounting.

Rack mounting

The power supply could be installed in standard 19 inch rack. Please remove the rubber bumpers at the front and end of power supply before installing.

2

----- Initial operation

Initial operation

This chapter mainly focuses on three basic tests before using the power supply: the preliminary checkout, the power-on checkout, and the output checkout. The preliminary checkout is to check the power supply could run correctly. The power-on test includes a self-test that checks the internal microprocessors and allows the user visually to check the display at the front panel under the condition of applying power to the supply properly. The output check ensures that the power supply develops its rated outputs and properly responds to operation from the front panel.



** In order to make sure whether the power supply is in accordance with what is required and have better command of power supply features for later use, it is suggested that both the experienced and the inexperienced users should read this chapter prior to operation*

Preliminary Checkout

ARRAY 3631A power supply can be used from a nominal 115 V or 230 V single phase AC power source at 47 to 63 Hz. There is an indication below the AC power inlet on the rear panel showing the nominal input voltage set for the power supply at the factory.

Power line cord

The power supply is shipped from the factory with a power-line cord that has a plug appropriate for your location. Please contact the nearest ARRAY Sales and Service Office if the wrong power-line cord is included with your power supply. Your power supply is equipped with a 3-wire grounding type power cord; the third conductor being the ground. The power supply is grounded only when the power-line cord is plugged into an appropriate receptacle. Do not operate your power supply without adequate cabinet ground connection.

Power-Line Voltage Selection

Usually power-line voltage has been set at the factory. Please check the indication on the rear panel before using to make sure the input voltage. Power-line voltage selection is accomplished by adjusting two components if modification needed: AC power-line voltage selector and power-line fuse. To change the power-line voltage, proceed as follows:

2. The modification of AC power-line voltage selector is shown as follows:

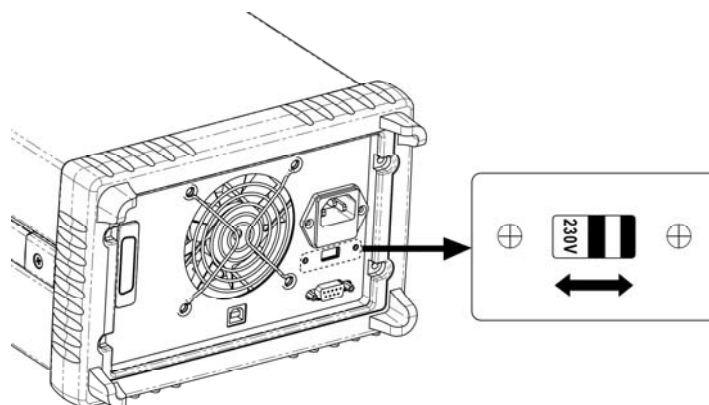

As the figure shows, you can choose distinct input voltage by moving the selection switch to left or right to accord with the location standard voltage.

2. Replace the fuse:

Step 1. Remove the fuse-holder with a flat-blade screwdriver from the rear panel.

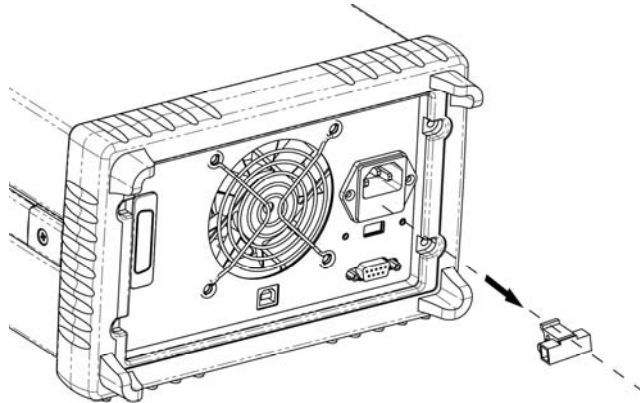

Step 2. Replace the fuse with the correct one that meets the requirements.

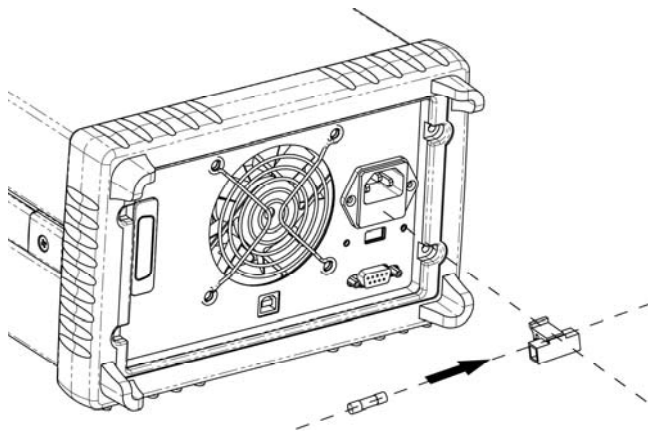

Step 3. Put back the fuse holder.

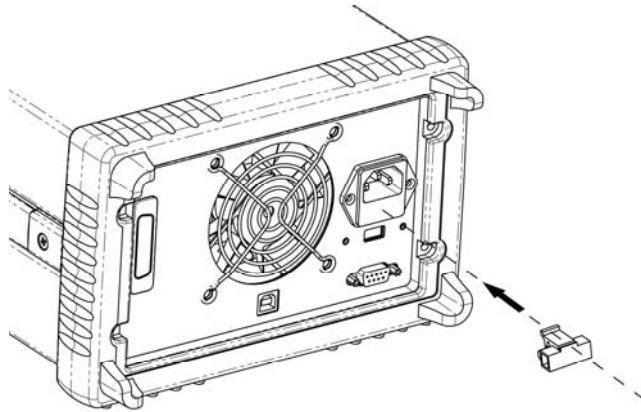

**For 115Vac operation, 2.5AT fuse must be used;
For 230Vac operation, 2.0AT fuse must be used.**

Specific checks could be accomplished by following 3 steps:

1. Verify the AC power supply voltage setting

The AC power supply voltage is set to the proper value for your country when the power supply is shipped from the factory. However, it is still needed to make sure whether the voltage value on the rear panel accords with the voltage default. Change the voltage setting if it is not correct. The settings are: 115, or 230 V.

2. Verify that the power-line fuse is installed correctly.

The correct fuse is installed for your country when the power supply is shipped from the factory. But checks are still needed to verify the fuse on the rear panel is installed and the specification is appropriate for the power supply.

For 115 Vac operation, you must use a 2.5 AT fuse.

For 230 Vac operation, you must use a 2.0 AT fuse.

3. Connect the power-line cord and turn on your powersupply.

A power-on self-test occurs automatically when you turn on the power supply. And the front-panel display will show the self-test procedure. Self-test costs about 2seconds.

Power-On Checkout

The power-on test includes an automatic self-test that checks the internal microprocessors and system self-test after the power supply is turned on and information related to self-test procedure shown on display. You will observe the following sequence on the display:

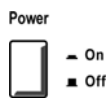

2. Self-test started

It begins to initial operation immediately after pressing the power switch on. Then self-test starts. The self-testing involves internal microprocessor and whole power supply system. The display shows as following:

SELFTEST

2. Self-test accomplished:

If there is no error or abnormality has been detected during self-testing, the display shows as following

PASS

3. Waiting for output:

When self-test accomplished, the power supply is in power-on or reset status. All outputs are disabled, and the output selection is +6V. The display shows as following:

OUTPUT OFF
+6V OFF

In the above figure, "OFF" shows that all outputs are disabled, and "+6V" shows that +6V power supply output is being monitored.

4. Enable the output



Press "OUT on/off" to enable the output. The "OFF" annunciator on display turns off, and the "+6V", "ON", "CV" annunciators turn on. At this time the display switches to monitoring mode automatically to monitor the actual value of voltage and current output



** If power-on self-test has detected any error or abnormality, the "ERROR" annunciator is lit. For specific information about errors please see related chapters in appendix.*

Output checkout

The output checkout is to ensure that the power supply develops its rated outputs and properly responds to each operation. Specific steps are shown as followings:

Voltage Output Checkout

Power



1. Turn on the power supply.

Press the “power-on” button, and finish the power-on checkout. Usually the power supply will go into the power-on / reset state automatically. All outputs are disabled (the “OFF” annunciator turns on); the display is selected for monitoring the +6V supply (the +6V annunciator turns on).



2. Enable the outputs

Press the “OUT on/off” to turn on the power supply output. Now the display is in monitoring mode and the CV, ON and +6V annunciators are lit. At the same time a 4-digit voltage meter and a 4-digit current meter are displayed. Each of them shows the actual value of output voltage and current of +6V power supply, respectively.



3. Check if the voltmeter properly responds to knob control on front panel for the +6V supply

Knob checkout

When the power supply output is on and the display is in monitoring mode, move the blinking digit to voltage value displayed by pressing the key “LEFT”. Turn the knob clockwise or counter clockwise to check that the voltmeter responds to knob control to increase or decrease and the ammeter indicates nearly zero.

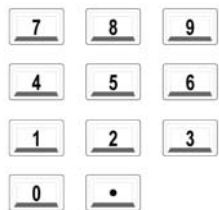

Key checkout

When the power supply output is on and the display is in monitoring mode, press key “VSET”, the SET annunciator turns on, and the voltage setting value is blinking. Press the number keys on front panel directly to set voltage value needed. Then press ENTER to verify and finish setting and go back to monitoring mode. This process is to check that the voltage value displayed responds the key operation correctly.



4. Check if the voltage can be adjusted from zero to the maximum rated value.

Adjust the knob until the voltmeter indicates 0 volts and then adjust the knob gradually until the voltmeter indicates 6.0 volts

and at the same time check the voltmeter and output voltage changes as it changes.

5. Check the voltage function for the +25V supply.
Adjust selection key for the +25V supply. The CV annunciator is lit and the +25V annunciator will turn on and +6V turns off. Repeat steps 3 and 4 to check the voltage function for the +25V supply.

6. Check the voltage function for the -25V supply.
Adjust selection key for the -25V supply. The CV annunciator is still lit and the -25V annunciator turns on and +25V annunciator turns off. Repeat steps 3 and 4 to check the voltage function for the -25V supply.

Current output checkout

1. Turn on the power supply and finish the power-on checkout. Usually the power supply will go into the power-on / reset state automatically; all outputs are disabled (the OFF annunciator turns on); the display is selected for monitoring the +6V supply (the +6V annunciator turns on).

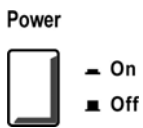

2. Connect a short across (+) and (-) output terminals of the +6V supply with an insulated test lead.

3. Enable the outputs.
Press the OUT on/off button, turn on the +6V supply and the display is in monitoring mode. The ON and +6V annunciators are lit. At the same time a 4-digit voltage meter and a 4-digit current meter are displayed, which show the actual value of output voltage and current of +6V power supply, respectively. The CV or CC modes depend on the resistance of the test lead.



4. Adjust the voltage limit value to 1.0 volt.
Adjust the voltage limit to 1.0 volt to assure CC operation. Please see related chapters about voltage and current setting in front panel in this manual for specific operations.



5. Check that the front-panel ammeter properly responds to knob control for the +6V supply.

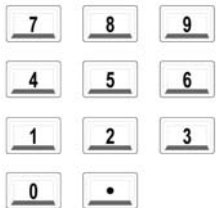

Knob checkout

When the power supply is on and the display is in monitoring mode, press key RIGHT to move the blinking digit to current value displayed; and turn the knob clockwise or counter clockwise to check if the current value displayed increases or decreases as it changes.

Key checkout

When the power supply is on and the display is in monitoring state, press key ISET, the SET annunciator will light on, and the current setting value is blinking. Press the number keys on front panel directly to set current value needed. Then press ENTER to verify and finish setting, go back to monitoring mode. This process is to check that the current value displayed responds the key operation correctly.

6. Ensure that the current can be adjusted from zero to the maximum rated value. Adjust the knob until the ammeter indicates 0 amps and then until the ammeter indicates 5.0 amps.

7. Check the current function for the +25V supply. Press OUT on /off, adjust the output selection key for the +25V supply and connect a short across (+) and (COM) output terminals of the $\pm 25V$ supply with an insulated test lead. Repeat steps from 3 to 6.

8. Check the current function for the -25V supply. Press OUT on /off, adjust the output selection key for -25V supply, and connect a short across (-) and (COM) output terminals of the $\pm 25V$ supply with an insulated test lead. Repeat steps 3 through 6.



**** If an error has been detected during the output checkout procedures, the ERROR annunciator will turn on. See the related chapters in appendix for more specific error information.***

3

----- Front panel operation

Front panel operation

The installation and initial operation of the power supply are introduced in the last chapter, and a brief introduction of power supply usage is included. This chapter will describe in detail the use of these front-panel keys and show how they are used to accomplish power supply operation.

- **Front-Panel Operation Overview**
- **Setting of limit value of voltage/current**
- **Constant Voltage setting**
- **Constant Current setting**
- **Tracking Operation setting for $\pm 25V$ supply**
- **Storing and Recalling Operating States**
- **Disabling the Outputs**
- **System-Related Operations**
- **USB Interface Configuration**
- **RS-232 Interface Configuration**
- **GPIB Interface Configuration**
- **Calibration Overview**

Front-Panel Operation Overview

Please read this chapter before using the power supply:

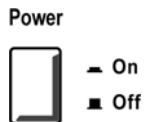

- * The AC Power On/Off key is used for switching the power supply on/off. The AC power is on when the key is pressed, and the AC power is off when the key bounces up.



- * Out On/Off key
The output of the power supply could be switched on or off through this button. When the output of the power supply is on, the "ON" annunciator on the front panel is lit; when the output of the power supply is off, the "OFF" annunciator on the front panel is lit. It is noticed that no matter which supply is being

monitored, the operation of switching on/off can be used for triple outputs. At the same time, all states and related information of present supply will be displayed on the display of front panel. So that users could have the knowledge of the working state of the power supply in time. Please see related chapters in the followings for details.



- * LEFT/RIGHT keys
Used to move the blinking digit on the display, or to switch the options.



- * Knobs are used to adjust and modify the values. Please see related chapters in the followings for specific introductions of related functions.

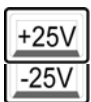

- * Output selection keys
Used to select the certain supply output which is needed to be monitored on the front panel.



- * Voltage setting key
Used to set the output voltage of the power supply. No matter which supply of +6V, +25V, or -25V is selected, just press this key can enter voltage setting mode to reset voltage value of present supply. Please see related chapters in the followings for specific introduction of related operations.



- * Current setting key
Used to set the output current of the power supply. No matter which supply of +6V, +25V, or -25V is selected, just press this key can enter current setting mode to reset current value of present supply. Please see related chapters in the followings for specific introduction of related operations.



- * Tracking key
Used to enable/ disable voltage tracking function of +25V and -25V power supply. Please see related chapters in the followings for specific introduction of related operations.



* Store key

It is used to store present working state of the power supply and to simplify the operation of working state transition of power supply. Related state information of power supply is stored in non-volatile memory of the micro-controller, which can be recalled by user at any time. Please see related chapters in the followings for specific introduction of related operations.

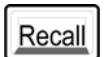

* Recall key

It is used to recall stored working state and to simplify the operation of the frequent working state transition of power supply. The state information recalled is stored in non-volatile memory of the micro-controller. Please see related chapters in the followings for specific introduction of related operations.



* Limit value setting key

Used to set output limit value of the power supply. The limit value is the maximum of voltage and current which each output supply is permitted to set. Press "Limit", the annunciator will light on. And the limit value of voltage and current of present output supply will be shown on display. The setting value will not exceed the limit value. Please see related chapters in the followings for specific introduction of related operations.

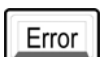

* Error checkout key

Used to check the error code occurred due to the misuse of hardware and software or various incorrect operations. So that users can know about error information in time and then use the power supply correctly. Please see related chapters in the followings for specific introduction of related operations.



* Local key

It is used to switch the power supply from remote mode to local mode without sending the key-locking command to power supply by remote interface. Please see related chapters in the followings for specific introduction of related operations.



- * I/O setting key
Used to set parameters of remote interface. Please see related chapters in the followings for specific introduction of related operations.

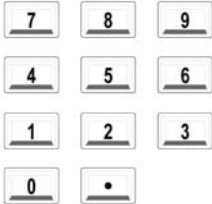

- * Number keys
Used to enter value needed in the related state.



- * Clear key
In different states, it is used to clear values entered at present, return to last step or quit present operation. Please see related chapters in the followings for specific introduction of related operations.



- * Enter key
It is used to confirm the numbers entered at present or operate or perform the order selected.

Setting limit value of voltage and current

The limit value of voltage set a maximum of voltage which the power supply permitted, and the limit value of current set a maximum of current which the power supply permitted. The limit value of voltage/current of +6V, +25V, -25V is 6.2V/5.2A, 26V/1.1A, -26A/1.1A.respectively. The users can reset the limit value of voltage and current if needed in order to restrict outputs or protect external circuits. There are two methods to set limit value of voltage and current from front panel:

1. Use Left/Right key, number keys, and Enter to change the limit value of voltage/current of the power supply.



- A. Press "Limit" to enter into limit value setting state. The limit value of voltage and current are shown on the display. The voltage limit value is blinking.

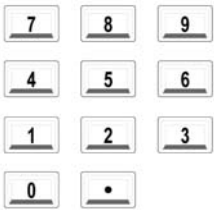
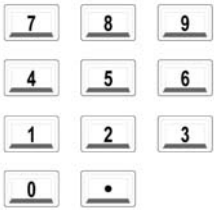

B. Use number keys to enter voltage limit value

C. Press Enter to confirm voltage limit value, and then switch to current limit value setting state.

D. Use number keys to enter current limit value.

E. Press Enter to confirm and the power supply will go back to waiting state automatically.

If you want to exit halfway, please press "Clear" .

2. Use Left/Right, knobs and Enter to change voltage/current limit value.

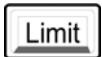

A. Press "Limit" to enter limit value setting state. The limit value of voltage and current are shown on the display. The voltage limit value is blinking.



B. Use Left/Right to select voltage limit value digit which needs to be modified. The data digit selected is blinking.



C. Increase or decrease the numbers to the needed by turning the knob clockwise or counter clockwise, then move to the next digit to modify by pressing Left/Right keys.



D. Press Enter to confirm voltage limit value and then switch to current limit value setting value.

E. Adjust Left/Right keys and knob for the desired current limit value as adjusting voltage limit value. Press "Enter" to confirm. The power supply will go back to waiting state automatically. If you want to exit halfway, please press "Clear".

Constant voltage output setting

Constant voltage output is the most common output of the power supply. The voltage outputs at a constant value in constant voltage output mode, and it will not change as the load changes while the current will. The CV annunciator on the display of front panel will turn on when the power supply is in constant current mode. The methods of constant voltage output are introduced in the following with +6V power supply as an example (the same as +25V, -25V)

1. Connect a load to the relevant output terminals.

Turn off the power supply. Connect the load to the relevant output terminals. Set +6V output as an example, connect the positive pole of the load to “+” terminal of the +6V output, and connect the negative pole to “-” terminal of the +6V output.

2. Turn on the power supply

Press the POWER ON/OFF button in the front panel. The power supply will go into power-on/ reset state after self-testing. Triple outputs are all off (the OFF annunciator turns on), the display is selected for monitoring the +6V output (the +6V annunciator turns on).

To set up the power supply for +25V supply or -25V supply operation, you should press the +25V or -25V key to select the display and adjust for +25V supply or -25V supply before proceeding to the next step.

3. Set desired output voltage

Desired output voltage can be set directly by pressing number keys or using LEFT/RIGHT key together with the knob.

A.Using number keys and Enter key to input:

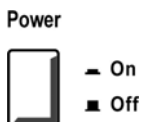

- ① Press VSET to enter into voltage setting state;

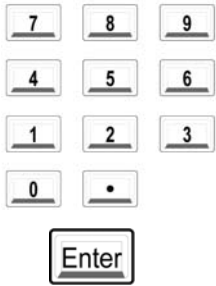

② Input the desired voltage value by pressing number keys, “Clear” key can be used to clear the wrong value to input again;

③ Press Enter Key to confirm the voltage setting value.

B. Use LEFT/RIGHT keys, knob and Enter key to input:



① Press VSET to enter into voltage setting state;



② Press LEFT/RIGHT keys to move the blinking digit to the relevant digit of the value.



③ Increase or decrease the relevant value by turning the knob clockwise or counter clockwise, then use LEFT/RIGHT keys to move to the next digit to modify. Clear key can be pressed to delete the wrong numbers if they are input by mistake.



④ Press Enter key to confirm the voltage setting value.

4. Set the maximum current

The maximum current can be set directly by pressing the number keys or using LEFT/RIGHT keys together with the knob.

A. Using number keys and Enter key to input:



① Press ISET to enter current setting state;



② Input the desired current value by pressing number keys, “Clear” key can be used to clear the wrong value to input again;



③ Press Enter Key to confirm the current setting value.

B. Use LEFT/RIGHT keys, knob and Enter key to input:

① Press ISET to enter current setting state;



② Press LEFT/RIGHT keys to move the blinking digit to the relevant digit of the value.



③ Increase or decrease the relevant value by turning the knob clockwise or counterclockwise, then use LEFT/RIGHT keys to move to the next digit to modify. Clear key can be pressed to delete the wrong numbers if they are input by mistake.



Press Enter key to confirm the current setting value.

**5. Enable the outputs.**

Press the OUT on/off key to enable the outputs. The “OFF” annunciator turns off and the ON and CV annunciators are lit.

Verify that the power supply is in the constant voltage mode. If you operate the power supply in the constant voltage (CV) mode, verify that +6V, ON and CV annunciators are lit. If you operate the power supply for the +25V supply or the -25V supply, the +25V or -25V annunciator will turn on. If the CC annunciator is lit while the CV annunciator turns off, which indicates that the actual output current value has reached our setting value, please choose a higher current limit.



*** During actual CV operation, if a load change causes the current limit to be exceeded, the power supply will automatically crossover to the constant current mode at the preset current limit and the output voltage will drop proportionately.**

When setting voltage or current, the voltage or current will be set as limit value if the value input on the keyboard is larger than the limit value.

Constant current output setting

When the power supply is in constant current mode, the current will output at a constant value, and it will not change as the load changes while the voltage will. The CC annunciator on the display of front panel will turn on when the power supply is in constant current mode.

The methods of constant current output are introduced in the following with +6V power supply as an example (the same as +25V, -25V).

1. Connect a load to the relevant output terminals.

Turn off the power supply. Connect the load to the relevant terminals. Set +6V output as an example, connect the positive pole of the load to “+” terminal of the +6V output, and connect the negative pole to “-” terminal of the +6V output.

2. Turn on the power supply

Press the POWER ON/OFF button in the front panel. The power supply will go into power-on/ reset state after self-testing. Triple outputs are all off (the OFF annunciator turns on), the display is selected for monitoring the +6V output (the +6V annunciator turns on).

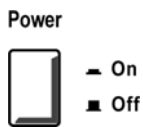

To set up the power supply for +25V supply or -25V supply operation, you should press the +25V or -25V key to select the display and adjust for +25V supply or -25V supply before proceeding to the next step.

3. Maximum output voltage setting

Desired output voltage can be set directly by pressing number keys or using LEFT/RIGHT key together with the knob.

A. Using number keys and Enter key to input:

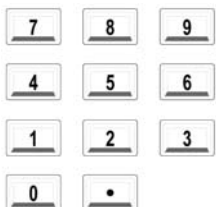

① Press VSET to enter voltage setting state;

② Input the desired voltage value by pressing number keys, “Clear” key can be used to clear the wrong value to input again;



③ Press Enter Key to confirm the voltage setting value.

B. Use LEFT/RIGHT keys, knob and Enter key to input:



① Press VSET to enter voltage setting state;



② Press LEFT/RIGHT keys to move the blinking digit to the corresponding digit of the value.



③ Increase or decrease the relevant value by turning the knob clockwise or counter clockwise, then use LEFT/RIGHT keys to move to the next digit to modify. Clear key can be pressed to delete the wrong numbers if they are input by mistake.



④ Press Enter key to confirm the voltage setting value.

4. Set the desired current

The desired current can be set directly by pressing the number keys or using LEFT/RIGHT keys together with the knob.

A. Using number keys and Enter key to input:



① Press ISET to enter into current setting state;

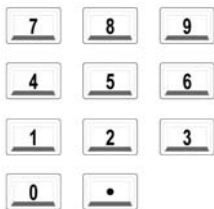

② Input the desired current value by pressing number keys, "Clear" key can be used to clear the wrong value to input again;



③ Press Enter Key to confirm the current setting value.

B. Use LEFT/RIGHT keys, knob and Enter key to input:



① Press ISET to enter into current setting state;



② Press LEFT/RIGHT keys to move the blinking digit to the corresponding digit of the value.



③ Increase or decrease the relevant value by turning the knob clockwise or counter clockwise, then use LEFT/RIGHT keys to move to the next digit to modify. Clear key can be pressed to delete the wrong numbers if they are input by mistake.



④ Press Enter key to confirm the current setting value.

5. Enable the outputs



Press the OUT on/off key to enable the outputs. The OFF annunciator turns off and the ON and CC annunciators are lit.

6. Verify that the power supply is in the constant current mode.

If you operate the power supply in the constant current mode, verify that +6V, ON and CV annunciators are lit. If you operate the power supply for the +25V supply or the -25V supply, the +25V or -25V annunciator will turn on. If the CV annunciator is lit while the CC annunciator turns off, please reset a higher current limit.



*** During actual CC operation, if a load change causes the output voltage exceeds the previous voltage setting value, the power supply will automatically crossover to the constant voltage mode according to the previous voltage setting value, and the output current will drop proportionately.**

*** When setting voltage or current, the voltage or current will be set as limit value if the value input on the keyboard is larger than the limit value.**

Adjusting output voltage

There are two methods of adjusting the output voltage when the outputs are enabled.

Method 1:

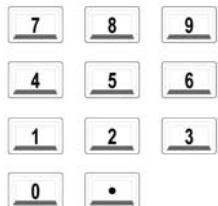

1. Press VSET key first as mentioned before;

2. Input the voltage value again by pressing the keys on the keyboard or turning the knob

3. Press “Enter” key to confirm at last

Method 2:



1. Press RIGHT key when actual voltage and current are shown on the display, then the last digit of the voltage value begins to blink;

2. Use LEFT/RIGHT keys to move the blinking digit;

3. Then turn the knob to adjust the value of the blinking digit;

4. Press RIGHT key to modify the next digit until all digits are not blinking; or wait for several seconds until the display exit the blinking state automatically.



**** Both of the above two methods can be used to adjust the output voltage, but notice that VSET key is used to adjust the output voltage in the first method, while actual output voltage does not change until the Enter key is pressed. In the second method, the output voltage has been changed while modifying the value of blinking digit through turning the knob without pressing the Enter key.***

Adjusting output current

There are two methods of adjusting the output current when the outputs are enabled.

Method 1:



1. Press ISET key first as mentioned before;

2. Input the current value by pressing the keys on the keyboard or turning the knob again

3. Press Enter key to confirm at last

Method 2:



1. Press LEFT key when actual voltage and current are shown on the display, then the last digit of the voltage value begins to blink;

2. Use LEFT/RIGHT keys to move the blinking digit;

3. Then turn the knob to adjust the value of the blinking digit;

4. After adjustment, press RIGHT key until all digits are not blinking; or wait for several seconds until the display exit the blinking state automatically.



**** Both of the above two methods can be used to adjust the output current ,but it is need to notice that ISET key is used to adjust the output current in the first method, while actual output current does not change until the Enter key is pressed. In the second method, the output voltage has been changed while modifying the value of blinking digit through turning the knob without pressing the Enter key.***

Setting $\pm 25V$ tracking operation

+25V and -25V supplies outputs are provided with voltage positive and negative inputs tracking function. In the track mode, the $\pm 25V$ supplies provide 0 to $\pm 25V$ tracking outputs, two voltages of the $\pm 25V$ supplies track each other within $\pm(0.2\% \text{ output} + 20\text{mV})$. When track mode is enabled, any change of the voltage in either the +25V supply or the -25V supply will cause the change in other supply. This function can provide steady symmetrical voltages needed by circuits using balanced positive and negative inputs. The track mode is always in off state when power has been off or after a remote interface reset.

To operate the power supply in the track mode, proceed as follows:

1. Switch to +25V or -25V supply output



Adjust the power supply to CV mode of +25V or -25V supply as mentioned before. "ON", "CV", and "+25V" or "-25V" annunciators are lit.

2. Enable the track mode

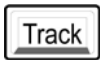

Press "Track" key and hold on for over 2 seconds to enable the track mode. Then the "Track" annunciator on the display turns on. And a short beep will be generated. When the track mode is first enabled, the -25V supply will be set to the same voltage level as the +25V supply. After the completion of setting, the two voltages of the $\pm 25V$ supplies track each other and any change of the voltage in either the +25V supply or the -25V supply will cause the change in other supply.

3. Verify that the power supply is in the track mode.

Compare the voltage values of the $\pm 25V$ supplies, and ensure the amplitudes of the output voltages of both supplies are the same, while the electrodes are opposite.

If you want to disable the track mode, just press “Track”key again, and the “Track” annunciator turns off.simultaneously.



** In the track mode of $\pm 25V$ supplies, if the CV annunciator turns off and the CC annunciator is lit in any supply of both ones, please choose a higher current limit for this supply, or the voltage will be unable to track.*

Storing and Recalling Operating States

ARRAY 3631A power supply can store 10 sets of operating states from 0 to 9. The users can just operate on the front panel simply to store common setting, which saves you a lot of time for adjusting the outputs and setting the working state of the power supply frequently, and simplifies operating procedures.

The states of the power supply after being turned on are as follows: all outputs are disabled, the track mode is off; the limit value of +6V, +25V and -25V voltage/current are 6.2V/5.2A, 26V/1.1A; -26V/1.1A, respectively; the setting value of voltage/current are 0V/5A, 0V/1A, 0V/1A; the keys and knob and the display on the front panel are used to control and monitor the output of +6V supply.

The following steps are showing how to store and operate an operating state:

1. Set up the power supply for the desired operating state.

Set up the power supply for the desired state, which including: outputs enabled/disabled; track mode setting; voltage/current

limit value output by each supply, voltage/ current setting value; keys, knob, the output object monitored by the display.

2. Store the operating state

10 states can be stored in the inner memory of 3631A, numbered from '0' to '9' without any preference in location. The contents stored in the memory will be covered when storing again.

A. Press Store key to enable the storage mode. The display of the front panel shows as follows:

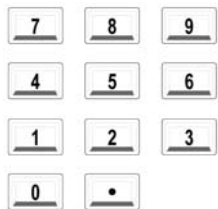

B. The blinking number shows the memory location, 10 sets of states can be stored in all from 0...9. The memory location could be chosen through number keys and knob.

C. Press Enter key to confirm, the following will appear on the display after the storing is done:

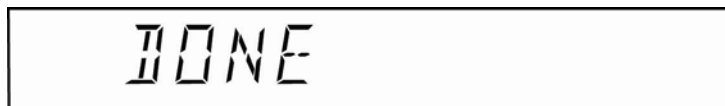

D. To cancel the storing operation, press "Store" key again or press "Clear" or just wait for several seconds without any operation, then the power supply will exit the storage mode automatically.



*** The output of the power supply will not be affected when the storing operation is on.**

3. Recalling operation

A. Press "Recall" key to enter recalling state, the display shows as follows:



B. The blinking number shows recalling location, which are numbered from 0-9 and can be chosen by the number keys and the knob.

C. Press Enter key to perform recalling. The states below will change as the recalling contents changes, which including: outputs enabled/disabled; track mode setting; voltage/current limit value output in each supply, voltage/current setting value; keys, knob, the output object monitored by the display.

To cancel the recalling operation, press "Recall" key again or press "Clear" key or just wait for several seconds without any operation, then the power supply will exit the recalling mode automatically.



*** The output of the power supply will change when the recalling operation is on.**

Enabling/Disabling the outputs



“OUT on/off” key can be used to turn on/off the output of the power supply.

When the power supply is turned off, “OUT on/off” key can be used to turn on the outputs. Press this key again to turn off the outputs again.

When the outputs of the power supply is off, “OUTPUT OFF” will appear on the display and the OFF annunciator will turn on. The keys and the knob still can be used. When the outputs are on, the actual value of voltage and current will appear on the display and the ON annunciator is on. If you want to see the setting value, press VSET or ISET to make the display in the voltage or the current setting mode.

When the power supply is off or after the reset of a remote interface, all the outputs are enabled.

When operating at a remote interface, enter the command as follow to enable or disable the outputs:



OUTPUT ON/OFF

The outputs are enabled when the “ON” parameter is selected and disabled when the “OFF” parameter is selected.

System-Related Operations

This section gives information on topics such as self-test, error information, and front-panel display control, SCPI version check, firmware version query. This information is not directly related to setting up the power supply but is an important part of operating the power supply.

Self-test

Self-test has been mentioned briefly in chapters before, and on which more detailed information is introduced here. A power-on self-test occurs automatically when you turn on the power supply. This test assures you that the power supply is operational if the self-test pass and no error occurs.

when the power-on self-test starts, the display shows as follows :

1. The self-test is on



A rectangular display box containing the word "SELFTEST" in a seven-segment font.

2. Self-test passed

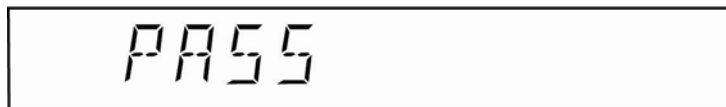

A rectangular display box containing the word "PASS" in a seven-segment font.

3. Enabling/Reset state



A rectangular display box containing the text "OUTPUT OFF" in a seven-segment font. Below the "OUTPUT" text is a small "+6V" label, and below the "OFF" text is a small "OFF" label.

If the error occurs during the self-test or the self-test fails, please contact with the distributor, or send it back to us. If error occurs, "PASS" will not be displayed on the display of the power supply. And the "ERROR" annunciator will turn on with a short beep after return to the enabling/reset state. As the following figure shows:



The command can also be sent through remote interface to perform self-test operation:

*TST?

Returns "0" if the complete self-test passes or "1" if it fails.

Error information

When the "ERROR" annunciator turns on, it indicates that at least an error is detected, which may be the remote interface command syntax or the hardware error. A record of up to 20 errors can be stored in the power supply's error queue. See "Error Messages" in the index of manual for a complete list of the error information.

1. Errors are retrieved in first-in-first-out (FIFO) order. The first error returned is the first error that was stored. When you have read all errors from the queue, the ERROR annunciator turns off.
2. If more than 20 errors have occurred when you operate the power supply over the remote interface, the last error stored in the queue (the most recent error) is replaced with "-350, "Too many errors"". No additional errors are stored until you have read errors or removed errors from the queue, which means that only 19 errors are able to see when operate the power supply over the remote interface, and the 20th error is replaced with "-350, "Too many errors"". .
3. If all errors are read or no errors have occurred, which shows no error is stored in the queue, the power supply responds with "0, "No error"" over the remote interface.

4. The error queue is cleared completely after a *CLS (clear status) command has been executed over the remote interface.

5. Front-panel operation:

If the ERROR annunciator is on, press the key repeatedly to read the errors stored in the queue. The "ERROR" annunciator turns off when you read all errors.

6. Remote interface operation:

SYSTEM:ERRor? Reads one error from the error queue

Display control

For security reasons, you can turn off the front-panel display, and display a 12-character message on the front panel. This function can be performed from the remote interface only.

1. When the display is turned off, outputs are not sent to the display and all annunciators are disabled except the ERROR annunciator and "Rmt" annunciator. Front-panel and knob operation is unaffected by turning off the display.
2. When the power is restarted, the display is always enabled after a remote interface reset, or after returning to local from remote.
3. You can display a message on the front panel by sending a command from the remote interface. The power supply can display English letters, Arabic numerals and spaces up to 12 characters of the message on the front panel; any additional characters are truncated. All the appeared special marks are displayed in the form of the blank spaces with individual display space respectively.
4. Sending a message to the display from the remote interface overrides the display state; this means that you can display a message even if the display is turned off.



5. The display state is automatically turned on when you return to the local (front panel) operation. Press the “Local” key to return to the local state from the remote interface

6. Remote interface operation commands:

DISPLAY ON/OFF
(Disable / enable the display)

DISPIAY: TEXT <single quoted string>
(Display the string enclosed in single quotes)

DISPIAY:TEXT:CLEAR
(Clear the displayed message and exit the display state)

For example, If you want to display “all123456789” charater string, send following message to the display:

```
DISPLAY:TEXT 'all123456789'
```

SCPI Language Version

The power supply complies with the rules and regulations of the present version of SCPI (Standard Commands for Programmable Instruments). You can query the SCPI version with which the power supply is in compliance by sending a command from the remote interface.

Remote interface operation command:

```
SYSTEM:VERSion?
```

Returns a string in the form “YYYY.V” where the “Y’s” represent the year of the version, and the “V” represents a version number for that year (for example, 1995.0).

Notes:

You can query the SCPI version from the remote interface only.

Firmware Revision Query

The power supply has microprocessors for control of various internal systems. You can query the power supply to determine which revision of firmware is installed for each microprocessor. You can query the firmware revision from the remote interface only.

Use commands below to check the firmware revision No. through remote interface:

*IDN?

Returned value:

ARRAY,3631A,0,1.3-1.0-1.5

The value returned is separated by commas and consisted of 4 fields. The first field represents the manufacturer, the second represents the model of the product, the third reserved, and the fourth field is a revision code which contains three numbers. The first number is the firmware revision number for the main processor; the second is for the input/output processor; and the third is for the front-panel processor.

Remote Interface Configuration

There are three manners of remote interface provided by ARRAY 3631A power supply: USB, RS-232 and GPIB (optional), which make the power supply to be used in different systems flexibly to meet the needs of different customers. In the following it will show how to configure these remote interfaces.



Remote Interface Selection

The power supply is shipped with an USB interface and an RS-232 interface and an GPIB (optional) on the rear panel. Only one interface can be enabled at a time during the operation. The RS-232 interface is selected when the power supply is shipped from the factory. Use I/O Config key on the front panel to choose interface.

Notes:

1. The interface selection is stored in non-volatile memory, and does not change when power supply restarts or after a remote interface reset.
2. If you select the RS-232 interface, you must select the baud rate, parity, and flow control to be used.
3. If you select the USB interface, you can just choose and confirm without any other settings.
4. If you select the GPIB interface, you must select an address for the power supply.

RS-232 Configuration

You connect the power supply to the RS-232 interface using the 9-pin (DB-9) serial connector on the rear panel. The power supply is configured as a DTE (Data Terminal Equipment) device which can accomplish the communication between the power supply and remote controller. The following sections will introduce how to configure the serial interface and the elimination of the faults.

RS-232 Configuration Overview

Using the following parameters to configure the RS-232 interface, for more detailed operation please consult the related chapters.

Baud Rate: 300, 600, 1200, 2400, 4800, 9600 baud (factory setting), 19200, 38400;

Parity : None / 8 data bits (factory setting)

Even / 7 data bits, or

Odd / 7 data bits

Flow control: ON(factory setting), OFF

Number of Start Bits: 1 bit (fixed)

Number of Stop Bits: 2 bits (fixed)

RS-232 Data Frame Format

A character frame consists of all the transmitted bits that make up a single character. The frame is defined as the characters from the start bit to the last stop bit, inclusively. Within the frame, you can select the baud rate, number of data bits, and parity type. The power supply uses the following frame formats for seven and eight data bits.

Data bits frame format



Start bit 7 data bits parity bit stop bit

8 data bits frame format



Connection to a Computer or Terminal

To connect the power supply to a computer or terminal through RS-232 interface, you must have the proper interface cable. 9 pins (DB-9 connector) configuration is used in our product. And a 9 pins (DB-9 connector) connecting cable is provided with the power supply. The internal cable pin diagram is shown below.

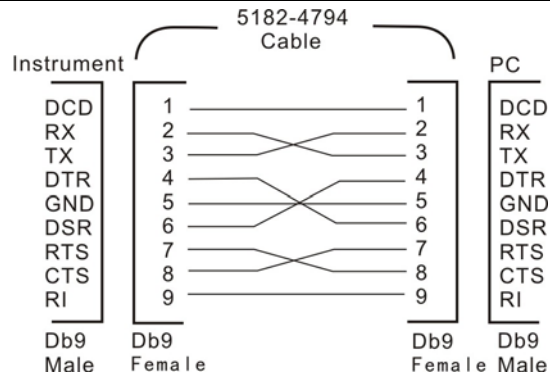

In addition, users can use simple serial cable instead if flow control is not needed. The diagram is shown below.

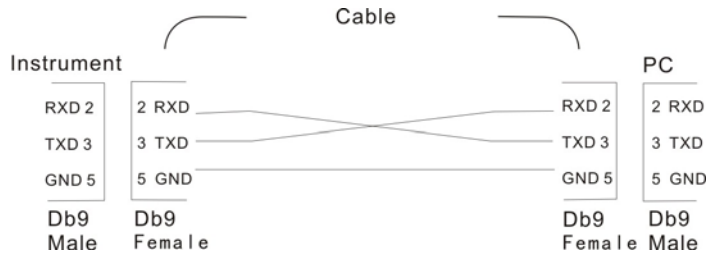

DTR/DSR Handshake Protocol

The power supply is configured as a DTE (Data Terminal Equipment) device and uses the DTR (Data Terminal Ready) and DSR (Data Set Ready) lines of the RS-232 interface to control the flow. The power supply uses the DTR line to send a hold-off signal. The DTR line must be TRUE before the power supply will accept data from the interface. When the power supply sets the DTR line FALSE, the data must cease within 10 characters. If flow control is not needed, DTR and DSR lines are not needed either. Select FLOWCON OFF for the flow control. And select a slower baud rate to make sure the data is transmitted correctly.

The power supply sets the DTR line FALSE in the following cases:

1. When the power supply's input buffer is full (when approximately 100 characters have been received), it sets the DTR line FALSE (pin 4 on the RS-232 connector). When enough characters have been removed to make space in the input buffer, the power supply sets the DTR line TRUE, unless the second case (see next) prevents this.

2. When the power supply wants to “talk” over the interface (which means that it has processed a query) and has received a <new line> message terminator, it will set the DTR line FALSE. This implies that once a query has been sent to the power supply, the bus controller should read the response before attempting to send more data. It also means that a <new line> must terminate the command string. After the response has been output, the power supply sets the DTR line TRUE again, unless the first case (see above) prevents this.

The power supply monitors the DSR line to determine when the bus controller is ready to accept data over the interface. The power supply monitors the DSR line (pin 6 on the RS-232 connector) before each character is sent. The data can be sent on condition that the DSR line is “TRUE”

The power supply holds the DTR line FALSE while output is suspended. A form of interface deadlock exists until the bus controller asserts the DSR line TRUE to allow the power supply to complete the transmission. You can break the interface deadlock by sending the <Ctrl-C> character, which can clear the sending and receiving of buffer area, and all the unexecuted commands and pending output will be discarded.

For the <Ctrl-C> character to be recognized reliably by the power supply while it holds DTR FALSE, the bus controller must first set DSR FALSE.

Baud Rate Selection

You can select one of eight baud rates for RS-232 operation as needed. The rate is set to 9600 baud when the power supply is shipped from the factory.

1. Select one of the following: 300, 600, 1200, 2400, 4800, 9600, 19200, 38400.
2. The baud rate selection is stored in non-volatile memory, and does not change when power has restarted or after a remote interface reset.

Parity Selection

You can select the parity for RS-232 operation. The power supply is configured for no parity and 8 data bits when shipped from the factory.

1. Select one of the following: None (8 data bits), Even (7 data bits), or Odd (7 data bits). Notice that the number of data bits has been set indirectly when you set the parity.
2. The parity selection is stored in non-volatile memory, and does not change when power restarts or after a remote interface reset.

The baud rate and the parity can be set from the front-panel only.

Flow control selection

Using a power supply over the RS-232 interface enables you to select the flow control or non-flow control. A slower baud rate should be chosen to make sure the data is transmitted correctly when the non-flow control is selected.

To set the Baud rate and parity

To configure the power supply for the RS-232 interface, proceed as follows:

1. Select the RS-232 interface



Press I/O Config key to enable the remote configuration mode as following:

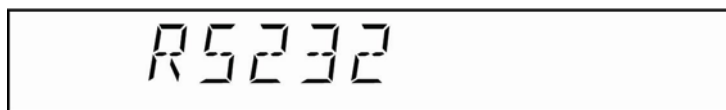

You will see the above message on the display if the power supply has not been changed from the default setting.

If the power supply has been changed, you can turn the knob or press Left/Right key to adjust.



Press Enter to select the RS-232 interface. Press Clear to cancel. This step can be skipped by pressing I/O Config key again,

2. Select the Baud rate

The display will appear as following after selecting RS-232 interface:

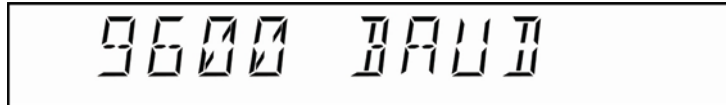

You will see the above message on the display if the power supply has not been changed from the default setting.

If the power supply has been changed, you can turn the knob or press Left/Right key to adjust until a desired option has been made from the following options: 300, 600, 1200, 2400, 4800, 9600 19200 or 38400 baud.

Press Enter key to choose the rate which the display is showing. Press I/O Config key again to skip this setting. And Clear key can be used to exit setting mode.

3 Parity selection

The display will appear as following after the Baud rate is selected:

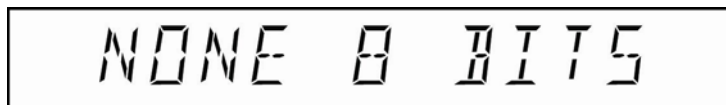

You will see the above message on the display if the power supply has not been changed from the default setting.

If the interface has been changed, you can turn the knob or press Left/Right key to adjust until a desired option has been made from the following options: None: no parity, 8 Bits, Even 7 Bits, or Odd7 Bits.

Press Enter key to choose the one which the display is showing. Press I/O Config key again to skip this setting. And Clear key can be used to exit setting mode.

4. Flow control selection

The flow control option will appear after the parity is selected:



You will see the above message on the display if the power supply has not been changed from the default setting.

If the power supply has been changed, you can turn the knob or press Left/Right key to adjust by turning the knob to the right or left. There are two options: ON and OFF. ON means to turn on the flow control, and OFF means to turn off the flow control. If the flow control is off, a slow baud rate should be selected to make sure that the data are transmitted.

Press Enter key to choose the one which the display is showing. Press I/O Config key again to skip this setting. And Clear key can be used to exit setting mode.

RS-232 Troubleshooting

Please check following aspects if any malfunction has occurred when you are communicating over the RS-232 interface. For additional help, please contact us.

1. Verify that you have connected the interface cable to the correct serial port on your computer.
2. Make sure that you have connected the correct interface cable and adapters. Even if the cable has the proper connectors for your system, the internal wiring may be incorrect. The incorrect internal wiring will result in the failure of communication. Please check it carefully.

3. Verify that the power supply and your computer are configured for the same baud rate, parity, and number of data bits. Make sure that your computer is set up for 1 start bit and 2 stop bits when it is communicating with ARRAY 3631A
4. Make sure to execute the SYSTEM: REMOTE command to place the power supply in the remote mode.

USB interface configuration

To use the USB interface, you need to install the USB driver program of ARRAY 3631A and the USB interface must be selected for the power supply.

Driver program installation

Place the Disk drive attached to the power supply into the PC's CD-ROM, then run the driver program and click the INSTALL. According to the default setting of driver program,click NEXT until the installation has finished

Remote interface configuration

The remote interface configuration can be operated only from the front panel. The following steps show how to select USB interface :



1. Turn on the power supply to enter the power on/reset state
2. Press "I/O Config"to enter remote interface selection mode
3. Select USB interface through turning the knob or pressing LEFT/RIGHT keys. The display shows as follow:





Press "I/O Config" again or press "Clear" key can cancel or exit the remote interface configuration mode at this time. If press "Enter" key, the USB interface will be selected for remote interface, and at the same time, the display shows momentarily as following:

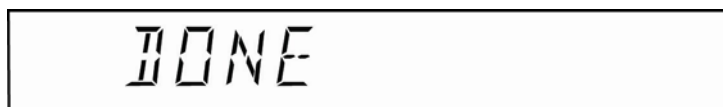

If the above figure appeared, it is verified that the selection is correct.

When the driver program is installed and the power supply interface is configured, the flow control power supply can be operated after being connected with proper USB cable.

GPIB interface configuration

Before you can operate the power supply over the GPIB interface, you must configure the power supply for the GPIB interface. The parameters will not be lost after the power is off or a remote reset. Each device on the GPIB (IEEE-488) interface must have a unique address. Notice that the bus controller's address can not be used for any instrument on the interface bus. You can set the power supply's address to any value between 0 and 30. The address is set to "05" when the power supply is shipped from the factory. When the user sets a new GPIB address, the default setting can be seen.

When connecting the GPIB devices, the following rules should be observed:

1. The total number of devices including the computer is no more than 15.

2. Do not stack more than three connector blocks together on any GPIB connector. Make sure that all connectors are fully seated and that the lock screws are firmly finger tightened.
3. The total length of all the cables used is no more than 2 meter times the number of devices connected together, up to a maximum of 20 meters. If the length of single cable is more than 4meters, the stability of the communication may be affected.

To configure the power supply for the GPIB interface, proceed as follows:

1. Turn on the power supply to enter the power-on or reset mode.



2. Press I/O Config key to enter remote selection mode
3. Turn the knob or press the Left/ Right key to select the GPIB interface. The display will appear as following :

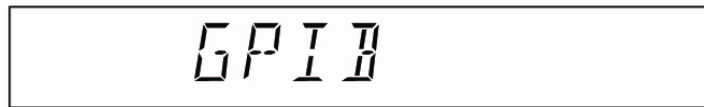

Press I/O Config key again or Clear key to exit setting mode. If you press "Enter" key, the GPIB is selected as remote interface. At the same time, the display will show momentarily as following:

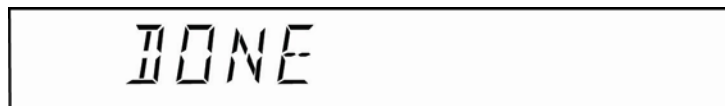

4. Set the device address. The unique device must be set for the device, which ranges from 0-30. The suitable value is entered by pressing the number keys, turning the knob or pressing "LEFT/RIGHT" keys. Give the address 05 as an example, the display shows as following:



ADDR 05



Press I/O Config key again to cancel this setting. And "Clear" key can be used to exit setting mode. The address in the display is selected for the GPIB bus address of instrument after pressing the "Enter" key, and the display shows momentarily as following:



DONE

The power supply calibration

Because various factors may cause the reduction of the power supply's output precision after using for a period of time, the user can calibrate the the power supply's output to make the output return to the previous precision. It is suggested that the power should not be calibrated frequently. This section is mainly introduced how to secure and unsecure the power supply and the detailed procedures of manual calibration.

Calibration password

The calibration is provided with security code to prevent accidental or unauthorized calibrations of the power supply. When you first receive your power supply, it is secured. Before you can calibrate the power supply, you must unsecure it by entering the correct security code.

The security code is set to ARRAY003631 when the power supply is shipped from the factory. The security code is stored in non-volatile memory, and does not change when power has been off or after a remote interface reset except entering a special command.

To secure the power supply from the remote interface, the security code may contain up to 12 letters or numerical characters or alphanumeric characters.

To secure the power supply from the remote interface so that it can be unsecured from the front panel, use the eleven-character format shown below. The first five characters must be "ARRAY" and the remaining six characters must be numbers. Only the last six characters are recognized from the front panel, but all eleven characters are required. To unsecure the power supply from the front panel, omit the "ARRAY" and enter the remaining six numbers as shown on the following

To Unsecure for Calibration

The power supply has to be unsecured first if the calibration is needed because it is secured when shipped from the factory. You can unsecure the power supply for calibration either from the front panel or over the remote interface. Give the following default security code 003631 as an example to explain the procedure of unsecuring.

1. Front panel operation

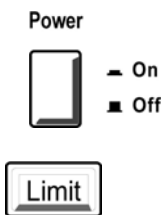

If the power supply is in the securing state previously, you will see the message shown as follow momentarily by pressing and holding the Calibrate key till you turn on the power supply, which shows the power supply is secured. Then the power supply is in the calibration mode. Please

enter the correct security code to unsecure the power supply if you proceed with calibrating operation.



The detailed operations shown as follow: press “Secure” key (the second function of “I/O config”), and the display shows as follow:



Give the security code 003631 as an example: Enter the correct security code, as the following figure shows:

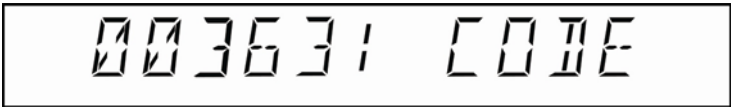

Press “Enter” key to verify. The power supply is unsecured when the security code is correct. Otherwise the relevant error information will appear on the display. After unsecuring the power supply successfully, the display shows the following message.



The power supply enters “CAL MODE” after being unsecured. Press “Enter” key again to begin the calibration.

2. Remote interface operation

Take the security code ARRAY 003631 as an example; the command format is shown as follow:

CALIBRATE: SECURE: STATE ON/OFF,<code>

To secure the power supply, send the above command with the same code used to unsecure. For example,

```
CALIBRATE: SECURE: STATE N, ARRAY003631  
<secured>
```

```
CALIBRATE: SECURE: STATE, ARRAY003631  
<unsecured>
```

To verify the security code is set, the command format is shown as follow:

```
CALIBRATE:SECURE:STATE ?
```

When the value returned is 1, the security code is set,
When the value returned is 0, the security code is not set.
Manual calibration

Your power supply was calibrated before it left the factory. But after being used for a period of time, a larger error of output will be produced due to external circumstance and some accidental operations. You can make use of the calibration function of power supply to calibrate again in order to reduce the error and increase the precision of the output. Notice that the power supply is not allowed to be turned off during the process of calibration.

To protect the calibration constants soundly, the power supply has to be unsecured before entering the calibration mode, and it is calibrated interactively. In order to ensure the calibration precision, a suitable external meter is needed. There are 4 calibration points to be calibrated for each output. They are the high and low voltage output and the high and low current output respectively. The power supply then computes new calibration constants, which are then stored in non-volatile memory and does not change when power has been off or after a remote interface reset. To avoid the error resulted from the misoperation or power off interruption, the power supply has been provided with the function of retoring to the default calibration parameters.

The detailed calibrating operations show as follow:

1. Enable the calibration mode, unsecure the power

Power



■ On
■ Off

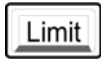

Press and hold the “Calibrate”key (the second function of the “Limit” key) until pressing the “Power” key to turn on the power supply.

The power supply also performs the self-test first, and displays the self-test information momentarily. Shows as follow:



SELFTEST

After self-testing, the power supply will verify the calibration security state of the system. If it is unsecured, you can operate calibration directly. If it is secured, please enter the correct security code to unsecure. For the detailed, please consult the relative information introduced before.

1) If it is secured, the display will show you the calibration is secured.



SECURED

Then return to the calibration mode, the display shows as follow:



CALI MODE



The calibration needs to be unsecured at this moment. Press "Secure" key (the "I/O Config" key) and then enter the security code. For the detailed, please consult the relative information introduced before.



Give the security code "003631" as an example, entering security code by using the number key:

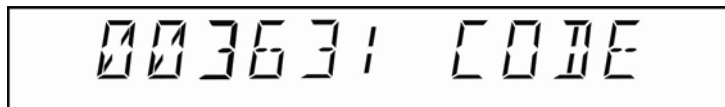

Make sure the security code is entered correctly, and press "Enter" key to confirm. Then the calibration is unsecured. The display shows as follow:



Then switch to the calibration mode automatically.



2) If the calibration is unsecured, the display shows as follw momentarily:

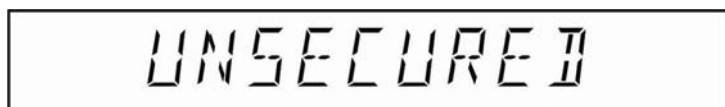

Then switch to the calibration mode:



2. Calibration

When the display shows as the above figure, press “Enter” key to enter the calibration program.

1) Calibrate the output of +6V power supply. The display shows as follow:



Adjust the the voltage meter to the appropriate range, and connect it to the output of +6V power supply correctly.



Then press “Enter” key to calibrate the calibration point that is the low voltage output of the +6V power supply. Shows as follow:



Observe the voltage value shown on the meter, and enter this voltage value correctly through the number key on the front-panel. Press “Clear”key to modify if entered incorrect value. Press “Enter” key after entering the correct value to calibrate the calibration point that is the high voltage output of the +6V power supply. Shows as follow:

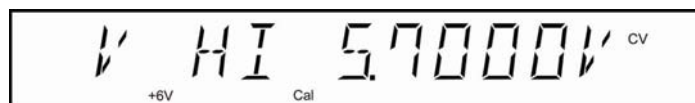

Clear

Enter

Observe the voltage value shown on the meter, and enter this voltage value correctly through the number key on the front-panel. Press "Clear" key to modify if entered incorrect value. Press "Enter" key after entering the correct value to enter the next calibration.

2) Calibrate the current output of the +6V power supply. The display shows as follow:



Enter

Adjust the the current meter to the appropriate range, and connect it to the output of +6V power supply correctly. Then press "Enter" key to calibrate the calibration point that is the low current output of the +6V power supply. Shows as follow:



Clear

Enter

Observe the current value shown on the meter, and enter this current value correctly through the number key on the front-panel. Press "Clear" key to modify if entered incorrect value. Press "Enter" key after entering the correct value to calibrate the calibration point that is the high current output of the +6V power supply. Shows as follow:

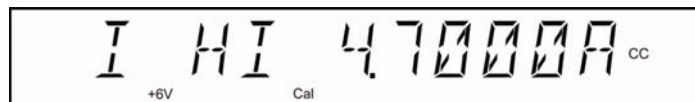

Clear

Enter

Observe the current value shown on the meter, and enter this current value correctly through the number key on the front-panel. Press "Clear" key to modify if entered incorrect value. Press "Enter" key after entering the correct value to enter the next calibration.

3) Calibrate the voltage output of +25V power supply. The display shows as follow:



Adjust the the voltage meter to the appropriate range, and connect it to the output of +25V power supply correctly. Then press “Enter” key to calibrate the calibration point that is the low voltage output of the +25V power supply. Shows as follow:



Observe the voltage value shown on the meter, and enter this voltage value correctly through the number key on the front-panel. Press “Clear”key to modify if entered incorrect value. Press “Enter” key after entering the correct value to calibrate the calibration point that is the high voltage output of the +25V power supply. Shows as follow:



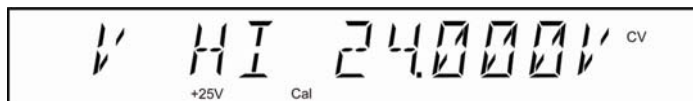

Observe the voltage value shown on the meter, and enter this voltage value correctly through the number key on the front-panel. Press “Clear”key to modify if entered incorrect value. Press “Enter” key after entering the correct value to enter the next calibration.





4) Calibrate the current output of +25V power supply. The display shows as follow.



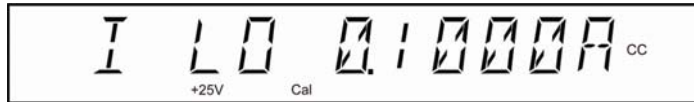

Adjust the the current meter to the appropriate range, and connect it to the output of +25V power supply correctly. Then press “Enter” key to calibrate the calibration point that is the low current output of the +25V power supply. Shows as follow:



Observe the current value shown on the meter, and enter this current value correctly through the number key on the front-panel. Press “Clear”key to modify if entered incorrect value. Press “Enter” key after entering the correct value to calibrate the calibration point that is the high current output of the +25V power supply. Shows as follow:



Observe the current value shown on the meter, and enter this current value correctly through the number key on the front-panel. Press “Clear”key to modify if entered incorrect value. Press “Enter” key after entering the correct value to enter the next calibration.

5) Calibrate the voltage output of -25V power supply. The display shows as follow.



Adjust the the voltage meter to the appropriate range, and connect it to the output of -25V power supply correctly. Then press “Enter” key to calibrate the calibration point that is the low voltage output of the -25V power supply. Shows as follow:



Observe the voltage value shown on the meter, and enter this voltage value correctly through the number key on the front-panel. Press “Clear”key to modify if entered incorrect value. Press “Enter” key after entering the correct value to calibrate the calibration point that is the high voltage output of the -25V power supply. Shows as follow:

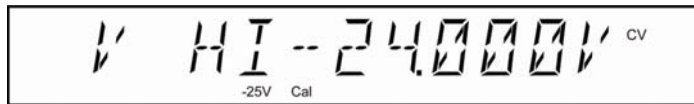

Observe the voltage value shown on the meter, and enter this voltage value correctly through the number key on the front-panel. Press “Clear”key to modify if entered incorrect value. Press “Enter” key after entering the correct value to enter the next calibration

6) Calibrate the current output of -25V power supply. The display shows as follow.



Adjust the the current meter to the appropriate range, and connect it to the output of -25V power supply correctly. Then press “Enter” key to calibrate the calibration point that is the low current output of the -25V power supply. Shows as follow:





Observe the current value shown on the meter, and enter this current value correctly through the number key on the front-panel. Press “Clear”key to modify if entered incorrect value. Press “Enter” key after entering the correct value to calibrate the calibration point that is the high current output of the -25V power supply. Shows as follow:



Observe the current value shown on the meter, and enter this current value correctly through the number key on the front-panel. Press “Clear”key to modify if entered incorrect value. Press “Enter” key after entering the correct value. The entire calibration of triple power supply output is completed. The display will show the success messege and then the power supply will return to the normal state.



**** To avoid the unauthorized or accidental calibration, it is suggested that the power supply should be secured after finishing the calibration. Please see the next section.***

Calibration security

This feature allows you to enter a security code to prevent accidental or unauthorized calibrations of the power supply. When you first receive your power supply, it is secured. Before you can calibrate the power supply, you must unsecure it by entering the correct security code. The following calibration will have no security code after the power supply has been unsecured except that the power supply is secured again.

Secure from the front-panel. The detailed operation shows as follow: (give the security code 003631 as an example):

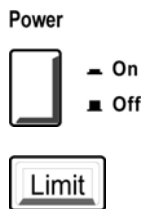

If the power supply is in the unsecure state, press and hold "Calibrate" key until the power supply is turned on. The display will appear the following message momentarily to show the power supply has been unsecured. Then the power supply enters the calibration mode.



Press the "Secure" key (the second function of the "I/Oconfig") to enter the setting security code mode. The display shows as follow:

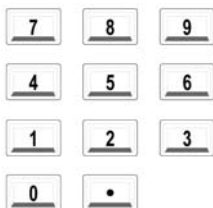

"000000" are the six valid numbers need to be setted. The first digit will be in blinking state. Give the security code "ARRAY003631" as an example, enter the six numbers "003631"

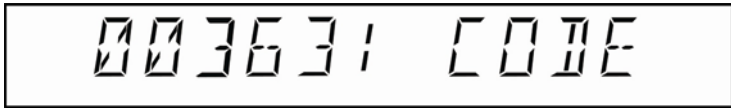

Press “Enter”key after verifying the six numbers entered correctly. Then the security code is setted and return to the CAL MODE after displaying the following message momentarily

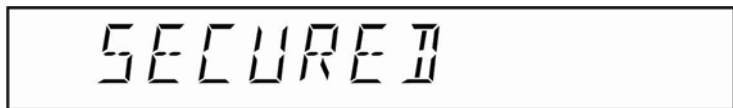

** After securing the power supply from the front-panel, please enter the default charater string “ARRAY” preceded the security code from the front-panel,if it needs to be unsecured from the remote interface.*

Change the Security Code

To change the security code, first make sure the power supply is unsecured.

Front-Panel Operation

To change the security code from the front-panel, the operation is the same as the operation of “Calibration security” introduced in the above section except for entering different security code.

Remote Interface Operation

To change the security code through the remote interface, the command shows as follow:

CALIBRATE:SECURE:CODE <new code>

Give the old code "ARRAY888888" and the new code "ARRAY123456" as an example, proceeds as follows:

CALIBRATE:SECURE:STAT OFF,ARRAY888888
<Unsecured with the old code>

CALIBRATE:SECURE:CODE ARRAY123456
<Enter the new code>

CALIBRATE:SECURE:STAT ON,ARRAY23456
<Secured with the new code>

Restore the default calibration parameters

When the user operate calibration, the calibration parameters may be lost or the error exceeds the limit value resulted from the misoperation or the power off interruption. The function of restoring the factory default calibration parameters can be used.

Steps are shown as follow:

1. use the same operation as the calibration to make the power supply enter normal mode, and make sure the calibration has been unsecured. The display shows as follow:



CALI MODE



2. Press "Left" key to enter the option of restoring factory calibration parameters. The display shows as follow:



RES FACTORY



3. Press "Enter" key to confirm, and the display shows the prompting message relevant. Shows as follow:

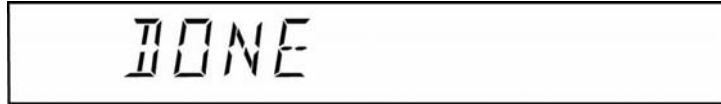

The power supply will return to the normal mode automatically when the operation is finished.

Initialize/initiate the calibration parameters

The incorrect calibrating operation may disorder the calibration parameters. Because the calibration is based on the previous calibration parameters, when the parameters are disordered it is impossible to have correct parameters by means of calibrating. Under this circumstance, it is necessary to clear and initialize /initiate the disordered parameters, then calibrate again.

The operation of initializing the calibration parameters shows as follow:

1. Operate the same way as operating calibration to enable the power supply enter the calibration mode and make sure the calibration has been unsecured. The display shows as follow:



2. Press "Left" key to enter the option of initializing calibration parameters, and the display shows as follow:





3. Press "Enter" key to confirm the initialization of calibration parameters, and the display shows the relevant prompting message. Shows as follows:



After completing the operation, the power supply will return to the normal mode, and have a larger error. Please calibrate the power supply again according to calibrating operation introduced before.

4

----- Remote Interface Reference

Remote Interface Reference

A detailed description of how to use the remote interface will be given in this chapter, which including how to program the power supply through the remote interface, the commands format and things need to be noticed.

- SCPI Command Summary
- Simplified Programming Overview
- Using the Apply Command
- Output Setting and Operation Commands
- Triggering Commands
- System-Related Commands,
- Calibration Commands
- RS-232 Interface Commands
- The SCPI Status Registers
- Status Reporting Commands
- An Introduction to the SCPI Language
- Halting an Output in Progress
- SCPI Conformance Information



***If this is the first time you use the SCPI language, it is suggested intensely to read this chapter attentively in order to become familiar with the language before attempting to program the power supply.**

SCPI Command Summary

This section is mainly introduced the the SCPI (Standard Commands for Programmable Instruments) commands available to program the power supply. Refer to the later sections in this chapter for more complete details on the format and function of each command.

Each SCPI command introduced in this section uses the following conventional format.

1. Square brackets ([]) indicate optional keywords or parameters.
2. Braces ({ }) enclose parameters within a command string.
3. Triangle brackets (< >) indicate that you must substitute a value or a code for the enclosed parameter.
4. A vertical bar (|) separates one of two or more alternative parameters.

An Introduction to the SCPI Language

SCPI (Standard Commands for Programmable Instruments) is an ASCII-based instrument command language designed for test and measurement instruments.

The detailed techniques used to program the power supply over the remote interface are introduced in the following sections.

SCPI commands are based on a hierarchical structure, also known as a tree system. In this system, associated commands are grouped together under a common node or root, thus forming subsystems. A portion of the SOURce subsystem is shown below to illustrate the tree system.

[SOURce:]

```
CURRent {<current>|MIN|MAX}
CURRent? [MIN|MAX]
CURRent:
    LIMit{<current>|MIN|MAX|DEF}
    LIMit?{MIN|MAX|DEF}
    TRIGger{<current>|MIN|MAX}
    TRIGger?{MIN|MAX}
VOLTage {<voltage>|MIN|MAX}
VOLTage? [MIN|MAX]
VOLTage:
    LIMit{<voltage>|MIN|MAX|DEF}
    LIMit?{MIN|MAX|DEF}
    TRIGger{<voltage>|MIN|MAX}
    TRIGger? {MIN|MAX}
```

SOURce is the root keyword of the command, CURRent and VOLTage are second-level keywords, and LIMit is third-level keywords. A colon (:) separates a command keyword from a lower-level keyword.

Command Format Used in This Manual

The format used to show commands in this manual is shown below:

```
CURRent {<current>|MINimum|MAXimum}
```

The command syntax shows most commands (and some parameters) as a mixture of upper- and lower-case letters. The upper-case letters indicate the abbreviated spelling for the command. For shorter program lines, send the abbreviated form. For better program readability, send the long form. But notice that only the complete spelling form and the upper-case letters are acceptable for the keyword. Give the following example to illustrate:

In the above syntax statement, CURR and CURRENT are both acceptable forms for the keyword "CURRent". You can use upper- or lower-case letters. Therefore, CURR, Curr, and CURr are all acceptable. Notice that the upper-case letters are indispensable, for example, "CUR" is incorrect. And "CURRe", "CURRen", will generate an error because of the incomplete spelling.

Braces "{ }" enclose the parameter choices for a given command string. The braces are not sent with the command string.

A vertical bar "|" separates multiple parameter choices for a given command string.

Triangle brackets "< >" indicate that you must specify a value for the enclosed parameter. For example, the above syntax statement shows the current parameter enclosed in triangle brackets. The brackets are not sent with the command string. You must specify a value for the parameter (such as "CURR 0.1").

Some parameters are enclosed in square brackets “[]” The brackets indicate that the parameter is optional and can be omitted. The brackets are not sent with the command string. If you do not specify a value for an optional parameter, a default value will be chosen by power supply.

A colon “:” separates a command keyword from a lower-level keyword. You must insert a blank space to separate a parameter from a command keyword. If a command requires more than one parameter, you must separate adjacent parameters using a comma as shown below:

```
SOURce:CURRent:TRIGgered
APPL P6V,3.5,1.5
```

Command Separators

A colon “:” is used to separate a command keyword from a lower-level keyword as shown below:

```
SOURce:CURRent:TRIGgered
```

A semicolon “;” is used to separate two commands within the same subsystem as shown below:

```
SOUR:VOLT MIN;CURR MAX
```

Executing the following two commands has the same effect as the above command.

```
SOUR:VOLT MIN7
SOUR:CURR MAX
```

Use a colon and a semicolon to link commands from different subsystems.

For example, in the following command string, an error is generated if you do not use the colon and semicolon:

```
INST P6V;;SOUR:CURR MIN
```

Using the MIN and MAX parameters

You can substitute MINimum or MAXimum in place of a parameter for many commands. For example, consider the following command:

```
CURRent {<current>|MIN|MAX}
```

Instead of selecting a specific current, you can substitute MINimum to set the current to its minimum value or MAXimum to set the current to its maximum value.

Querying Parameter Settings

You can query the value of most parameters by adding a question mark (?) to the command. For example, the following command sets the output current to 5 amps:

```
CURR 5
```

You can query the value by executing:

```
CURR?
```

You can also query the minimum or maximum value allowed with the present function as follows:

```
CURR? MAX  
CURR? MIN
```

SCPI Command Terminators

A command string sent to the power supply must terminate with a <new line> character. The IEEE-488 EOI (end-or-identify) message is interpreted as a <new line> character and can be used to terminate a command string in place of a <new line> character. A <carriage return> followed by a <new line> is also accepted. Command string termination will always reset the current SCPI command path to the root level.

SCPI Parameter Types

The SCPI language defines several different data formats to be used in program messages and response messages.

Numeric Parameters: Commands that require numeric parameters will accept all commonly used decimal representations of numbers including optional signs, decimal points, and scientific notation. Special values for numeric parameters like MINimum, MAXimum, and DEFault are also accepted. You can also send engineering unit suffixes (V, A or SEC) with numeric parameters. If only specific numeric values are accepted, the power supply will automatically round the input numeric parameters. The following command uses a numeric parameter:

```
CURR {<current>|MINimum|MAXimum}
```

Discrete Parameters: Discrete parameters are used to program settings that have a limited number of values (like BUS, IMM). Query responses will always return the short form in all upper-case letters. The following command uses discrete parameters:

```
TRIG:SOUR {BUS|IMM}
```

Boolean Parameters: Boolean parameters represent a single binary condition that is either true or false. For a false condition, the power supply will accept "OFF" or "0". For a true condition, the power supply will accept "ON" or "1". When you query a boolean setting, the power supply will always return "0" or "1". The following command uses a boolean parameter:

```
DISP {OFF|ON}
```

String Parameters: String parameters can contain virtually any set of ASCII characters. A string must begin and end with matching quotes; either with a single quote or with a double quote. You can include the quote

delimiter as part of the string by typing it twice without any characters in between. The following command uses a string parameter:

DISPlay:TEXT <quoted string>

Output Setting and Operation Commands

APPLy
 {P6V|P25V|N25V},{<voltage>|DEF|MIN|MAX},{<current>|DEF|MIN|MAX}}
 APPLy? [{P6V|P25V|N25V}]
 INSTRument
 [:SElect] {P6V|P25V|N25V}
 [:SElect]?
 :NSElect {1|2|3}
 :NSElect?
 :COUPle[:TRIGger] {ALL|NONE|<list>}
 :COUPle[:TRIGger]?
 MEASure
 :CURRent[:DC]? [{P6V|P25V|N25V}]
 [:VOLTage][:DC]? [{P6V|P25V|N25V}]
 Output
 [:STATe] {OFF|ON}
 [:STATe]?
 :TRACk[:STATe] {OFF|ON}
 :TRACk[:STATe]?
 [SOURce:]
 CURRent[:LEVel][:IMMediate][:AMPLitude]
 {<current>|MIN|MAX}
 CURRent[:LEVel][:IMMediate][:AMPLitude]? [MIN|MAX]
 CURRent[:LEVel]:LIMit[:AMPLitude]
 {<current>|MIN|MAX|DEF}
 CURRent[:LEVel]:LIMit[:AMPLitude]? {MIN|MAX|DEF}
 CURRent[:LEVel]:TRIGgered[:AMPLitude]
 {<current>|MIN|MAX}
 CURRent[:LEVel]:TRIGgered[:AMPLitude]? [MIN|MAX]
 VOLTage[:LEVel][:IMMediate][:AMPLitude]
 {<voltage>|MIN|MAX}
 VOLTage[:LEVel][:IMMediate][:AMPLitude]? [MIN|MAX]
 VOLTage[:LEVel]:LIMit[:AMPLitude]

```

{<voltage>|MIN|MAX|DEF}
VOLTage[:LEVel]:LIMit[:AMPLitude]? {MIN|MAX|DEF}
VOLTage[:LEVel]:TRIGgered[:AMPLitude]
{<voltage>[MIN|MAX]}
VOLTage[:LEVel]:TRIGgered[:AMPLitude]? [MIN|MAX]

```

Triggering Commands

```

INITiate[:IMMEDIATE]
TRIGger[:SEQUENCE]
:DELay {<秒>|MIN|MAX}
:DELay?
:SOURce {BUS|IMM}
:SOURce?

```

*TRG

System-Related Commands

```

DISPlay[:WINDow]
[:STATe] {OFF|ON}
[:STATe]?
:TEXT[:DATA] <quoted string>
:TEXT[:DATA]?
:TEXT:CLEAr
SYSTem
:BEEPer[:IMMEDIATE]
:ERRor?
:VERSion?

```

*IDN?

*RST

*TST?

*SAV {1|2|3}

*RCL {1|2|3}

Calibration commands

```

CALibration
:COUNT?

```

:CURRent[:DATA] <numeric value>
:CURRent:LEVel {MIN|MAX}
:SECure:CODE <new code>
:SECure:STATe {OFF|ON},<code>
:SECure:STATe?
:STRing <quoted value>
:STRing?
:VOLTage[:DATA] <numeric value>
:VOLTage:LEVel {MIN|MAX}

Status Reporting Commands

STATus:QUEStionable
[:EVENT]?
:ENABle <enable value>
:ENABle?
:INSTrument[:EVENT]?
:INSTrument:ENABle <enable value>
:INSTrument:ENABle?
:INSTrument:ISUMmary<n>[:EVENT]?
:INSTrument:ISUMmary<n>:CONDition?
:INSTrument:ISUMmary<n>:ENABle <enable value>
:INSTrument:ISUMmary<n>:ENABle?
SYSTem:ERRor?
*CLS
*ESE <enable value>
*ESE?
*ESR?
*OPC
*OPC?
*PSC {0|1}
*PSC?
*SRE <enable value>
*SRE?
*STB?
*WAI

RS-232 Interface Commands

SYSTem

- :LOCal
- :REMote
- :RWLock

Simplified Programming Overview

This chapter gives an overview of the basic commands used to program the power supply over the remote interface. Some of them are the SCPI-confirmed commands, and some are the device-specific commands. It is unnecessary to differentiate them when using ARRAY 3631

Using the APPLy Command

The APPLy command provides the most straightforward method to program the power supply over the remote interface, such as to control one output or triple outputs of power supply, and to read the immediate output value of each supply etc. Give the following example to illustrate:

APPLY P6V,3.3,2.0	set the +6V supply to an output of 3.3V rated at 2.0A
APPLY P25V,12.0,0.5	set the +25V supply to an output of 12.0V rated at 0.5A
APPLY N25V,-15.0,0.1	set the -25V supply to an output of -15.0V rated at 0.1A

Using the Low-Level Commands

The main feature of the low-level commands is to provide you with more flexibility to change or query the individual parameters than the APPLy command. Give the following example to illustrate how to use the low-level commands to set the +6V supply to an output of 5.0V rated at 4.0A:

```
INST P6V
VOLT 3.3
CURR 2.0
```

The three commands shown in this example has the same function as the first command shown in the above example, which shows when change the individual parameters, there is no need to enter the whole setting parameters as shown in the above example, just enter the individual parameters .

Reading a Query Response

Only the query commands (commands that end with “?”) will instruct the power supply to send a response message. Queries return either output values or internal instrument settings. Give the following example to illustrate:
For example, the following statements executed from your computer will read the power supply's error queue and print the most recent error:e

SYST:ERR?	Query and read the error message, and return a relevant error message.
CAL:SEC:STAT?	Query the calibration security, and return the relevant value.
SYST:VERS ?	Query the system version, and return the <u>version number</u> accordingly.

Selecting a Trigger Source

The power supply will accept a “bus” (software) trigger or an immediate internal trigger as a trigger source. By default, the “BUS” trigger source is selected. If you want the power supply to use an immediate internal trigger, you must select “IMMEDIATE”. For example,

TRIG:SOUR IMM Select an immediate internal trigger as a trigger source

INIT Initiate the trigger system

Programming Ranges and Output Identifiers

Output setting commands require a parameter for programming ranges and an output name or an output number as the identifier of each output. The following table lists the programming ranges, output names, and output numbers for each output.

Refer to this table to identify parameters when programming the power supply.

		output		
		+6V	+25V	−25V
output identifier		P6V	P25V	N25V
output number		1	2	3
Voltage	programming range	0 to 6.20V	0 to 26V	0 to -26V
	MAX value	6.20V	26V	-26V
	MIN value	0V	0V	0V
	Reset value(DEFault value)	0V	0V	0V
Current	programming range	0 to 5.2A	0 to 1.1A	0 to 1.1A
	MAX value	5.2A	1.1A	1.1A
	MIN value	0A	0A	0A
	Reset value(DEFault value)	5A	1A	1A

Using the APPLy Command

APPLy

{P6V|P25V|N25V}[,<voltage>|DEF|MIN|MAX][,<current>|DEF|MIN|MAX]]

This command is to specify the power supply output, which can be divided into four parts.

The first part is the keyword "APPLy"

The second part is to select the output {P6V|P25V|N25V}, by which you can select any one output from the +6V or ±25V power supply outputs. (P6V|P25V|N25V are the output identifiers for each output.)

The third part is to set the voltage value <voltage>|DEF|MIN|MAX, by which you can set the output voltage value of the specified output supply. For the setting range, please consult the relevant voltage parameters listed in the above table of "Programming Ranges and Output Identifiers" section.

The fourth part is to set the current value <current>|DEF|MIN|MAX, by which you can set the output current value of the specified output supply. For the setting range, please consult the relevant current parameters listed in the above table of "Programming Ranges and Output Identifiers" section.

When set the voltage and current the "DEF|MIN|MAX" represents the default value, the minimum value and the maximum value respectively.

For example:

APPLY P6V,5.0,2.5 set the +6V supply to an output of 5.0V rated at 2.5A



**Executing the low-level commands has the same effect as this command . Please refer to the last section.*

APPLy? [{P6V|P25V|N25V}]

This command queries and returns the power supply's present voltage and current values for each output. For example:

APPLy? P6V Queries and returns the voltage and the current setting values of +6V power supply.

Output Setting and Operation Commands

This section describes the low-level commands used to program the power supply. Although the APPLy command provides the most straightforward method to program the power supply, the low-level commands give you more flexibility to change individual parameters, which includes output selection commands, measurement commands, output on/off and tracking operation commands and output setting commands.

Output Selection Commands

INSTrument[:SElect] {P6V|P25V|N25V}

This command selects the output to be programmed among three outputs by the output identifier. When one output is selected, the other outputs are unavailable for programming until selected. The INSTrument command provides a mechanism to identify and select an output. P6V is the identifier for the +6V output; P25V is the identifier for the +25V output; and N25V is the identifier for the -25V output.
for example:

INSTrument N25V Select the -25V output to be programmed

INSTrument[:SElect]?

This command is to query and return the currently programmed output and the returned parameter is "P6V", "P25V", or "N25V".

Give the currently programmed -25V output as an example:

INST?

The following value will be returned:

N25V

INSTrument:NSElect {1|2|3}

This command selects the output to be programmed among three outputs by a numeric value instead of the output identifier used in the INSTrument [:SElect] command. When one output is selected, the other outputs are unavailable for programming until selected. "1" selects +6V output, "2" selects +25V output, and "3" selects -25V output.

For examp

INST:NSEL 2 Select +25V output to be programmed

INSTrument:NSElect?

This query returns the currently selected output by the INSTrument:NSElect or INSTrument[:SElect] command. The returned parameter is "1" for +6V output, "2" for +25V output or "3" for -25V output. Give the currently programmed -25V output as an example:

```
INST:NSEL?
```

The following value will be returned :

```
3
```

INSTrument:COUPlE[:TRIGger] {ALL|NONE|<list>}

This command defines a coupling between various logical outputs of the power supply. The couple command consists of an optional subsystem node followed by a single parameter. The only valid parameter for the optional subsystem node is TRIGger subsystem. The parameter indicates to which logical outputs the specified coupling is to apply. "ALL" indicates that specified coupling is to apply to all outputs.

"NONE" indicates that specified coupling is to be removed. A list of outputs specifies a particular set of logical outputs to be coupled. At *RST, all outputs are uncoupled. Notice that TRACk must be off before the $\pm 25V$ supplies can be coupled. for example:

INST:SEL P6V	Select the +6V output
VOLT:TRIG 3.3	Set triggered level to 3.3V
CURR:TRIG 1	Set triggered level to 1A
INST:SEL P25V	Select the +25V output
VOLT:TRIG 15	Set the triggered level to 15V
CURR:TRIG 0.5	Set the triggered level to 0.5A
INST:COUP P6V,P25V	Couple the +6V and +25V supply
TRIG:SOUR IMM	Set trigger to immediate
INIT	Trigger the power supply to output the trigger values for the +6V And the +25V supplies.

The above program segment shows how to use the INST : OUP { } command to couple two outputs between the +6V and the +25V outputs with voltage and current triggered levels. The power supply is set to the newly programmed values as set by the VOLTage:TRIGgered and CURRent:TRIGgered commands.

INSTrument:COUPlE[:TRIGger]?

This query returns the currently coupled output. Returns “ALL”, “NONE”, or a list. If any output is not coupled, “NONE” is returned. If all of three outputs are coupled, “ALL” is returned. If a list of outputs is coupled, the list is returned. Give the coupled +6V and +25V outputs as an example, the returned value is:

P6V,P25V

Measurement Commands

MEASure:CURRent[:DC]? [{P6V|P25V|N25V}]

This command measures and returns the current value at the present output terminals of the power supply. The physical outputs of measurement are specified by the output identifier. If any output identifier is not specified, the current of the selected output is returned.

MEASure :VOLTage[:DC]? [{P6V|P25V|N25V}]

This command measures and returns the voltage value at the present output terminals of the power supply. If any output identifier is not specified, the voltage of the currently selected output is returned.

Output On/Off and Tracking Operation Commands

Output[:STATe] {OFF|ON}

This command enables or disables all three outputs of the power supply.

For example:

OUTPUT ON	<i>enables all three outputs</i>
OUTPUT OFF	<i>disables all three outputs</i>

Output[:STATe]?

This command queries the output state of the power supply and returns the corresponding values. "OFF" shows the output is disabled, and "ON" shows the output is enabled.

Output:TRACk[:STATe] {OFF|ON}

This command enables or disables $\pm 25\text{V}$ tracking mode. The $\pm 25\text{V}$ supplies must not be coupled before executing this command. When the track mode is first enabled, the -25V supply will be set to the same voltage level as the $+25\text{V}$ supply. Once enabled, any change of the programmed voltage level in either $+25\text{V}$ supply or -25V supply will be reflected in the other supply. At remote interface and *RST state, the track mode is disabled.

Output:TRACk[:STATe]?

This command queries the track mode state of the power supply. The returned "OFF" indicates the track mode is disabled, and the returned "ON" indicates the track mode is enabled.

Output Setting Commands

```
[SOURce:]CURRent[:LEVel][:IMMEDIATE][:AMPLitude]
{<current>[MIN|MAX]}
```

This command directly programs the immediate current level of the power supply. The immediate level is the current limit value of the output selected with the INSTRUMENT command.

[SOURce:]CURRent[:LEVel][:IMMEdiate][:AMPLitude]?
[MIN|MAX]

This command queries and returns the immediate current value at the present output terminals of the power supply or the maximum and minimum programmable current levels of the selected output.

For example:

CURR? Queries and returns the immediate current value of the selected output.

CURR? MAX Queries and returns the maximum programmable current levels of the selected output.

CURR? MIN Queries and returns the minimum programmable current levels of the selected output.

**[SOURce:]CURRent[:LEVel]:LIMit[:AMPLitude]
{<current>|MIN|MAX|DEF}**

This command is to set the maximum current limit value of the presently programmed output selected with INST command.

**[SOURce:]CURRent[:LEVel]:LIMit[:AMPLitude]?
|MAX|DEF}**

This query returns the presently programmed current limit level of the selected output, or the maximum/minimum/default programmable current values of the selected output.

**[SOURce:]CURRent[:LEVel]:TRIGgered[:AMPLitude]
{<current>|MIN|MAX}**

This command programs the pending triggered current level of the power supply. The pending triggered current level is a stored value that is transferred to the output terminals when a trigger occurs. A pending triggered level is not affected by subsequent CURRent commands.

**[SOURce:]CURRent[:LEVel]:TRIGgered[:AMPLitude]?
[MIN|MAX]**

This query returns the presently programmed triggered current level. If no triggered level is programmed, the CURRent level is returned.

CURRent:TRIGgered? Returns the CURRent level or the current level of the selected output.

CURRent:TRIGgered? MAX Returns the maximum programmable current values of the selected output.

CURRent:TRIGgered? MIN Returns the minimum programmable current values of the selected output.

**VOLTage[:LEVel][:IMMediate][:AMPLitude]
tage>[MIN|MAX]**

This command directly programs the immediate voltage level of the power supply. The immediate level is the voltage limit value of the selected output with the INSTRument command.

**[SOURce:]VOLTage[:LEVel][:IMMediate][:AMPLitude]?
[MIN|MAX]**

This command queries and returns the immediate voltage value at the present output terminals of the power supply or the maximum and minimum programmable voltage levels of the selected output. For example:

VOLT? Queries and returns the immediate voltage value of the selected output.

VOLT? MAX Queries and returns the maximum programmable voltage levels of the selected output.

VOLT? MIN Queries and returns the minimum programmable voltage levels of the selected output.

**[SOURce:]VOLTage[:LEVel]:LIMit[:AMPLitude]
{<voltage>|MIN|MAX|DEF}**

This command is to set the maximum voltage limit value of the presently programmed output selected with INST command.

**[SOURce:]VOLTage[:LEVel]:LIMit[:AMPLitude]?
{MIN|MAX|DEF}**

This query returns the presently programmed voltage limit level of the selected output, or the maximum/minimum/default programmable voltage values of the selected output.

**[SOURce:]VOLTage[:LEVel]:TRIGgered[:AMPLitude]
{<voltage>|MIN|MAX}**

This command programs the pending triggered voltage level of the power supply. The pending triggered voltage level is a stored value that is transferred to the output terminals when a trigger occurs. A pending triggered level is not affected by subsequent VOLTage commands.

**[SOURce:]VOLTage[:LEVel]:TRIGgered[:AMPLitude]?
[MIN|MAX]**

This query returns the presently programmed triggered voltage level. If no triggered level is programmed, the VOLTage level is returned.

VOLTage:TRIGgered? Returns the VOLTage level or the triggered voltage level of the selected output.

VOLTage:TRIGgered? MAX Returns the maximum programmable voltage values of the selected output.

VOLTage:TRIGgered? MIN Returns the minimum programmable voltage values of the selected output.

Trigger Source Choice

The power supply's triggering system allows a change in voltage and current when receiving a trigger, to select a trigger source, and to insert a trigger. Triggering the power supply includes internal immediate triggering and bus triggering.

Triggering the power supply is a multi-step process:

1. Select an output with the `INST:[SElect]` command and then configure the power supply for the triggered output level by using `CURRent:TRIGgered` and `VOLTage:TRIGgered`
2. Specify the source from which the power supply will accept the trigger. The power supply will accept a bus (software) trigger or an immediate trigger from the remote interface.
3. Then, you can set the time delay between the detection of the trigger on the specified trigger source and the start of any corresponding output change. Notice that the time delay is valid for only the bus trigger source.
4. executing an `INITiate[:IMMediate]` command. If the `IMMediate` source is selected, the selected output is set to the triggered level immediately. But if the trigger source is the bus, the power supply is set to the triggered level after receiving the Group Execute Trigger (GET) or `*TRG` command.

Selecting a Trigger Source

You must specify the source from which the power supply will accept a trigger. The trigger is stored in volatile memory; the source is set to bus when the power supply has been off or after a remote interface reset.

Bus (Software) Triggering

1. To select the bus trigger source, send the following command.

TRIGger:SOURce BUS

2. To trigger the power supply from the remote interface (GPIB or RS-232) after selecting the bus source, send the *TRG (trigger) command. When the *TRG is sent, the trigger action starts after the specified time delay if any delay is given.
3. You can also trigger the power supply from the USB, RS-232 and GPIB interface. The operation has introduced before.

Immediate Triggering

1. To select the immediate trigger source, send the following command:

TRIGger:SOURce IMM

2. If the IMMEDIATE source is selected as a trigger source, the selected output is set to the triggered level immediately. Any delay is ignored.

Triggering Commands

INITiate[:IMMEDIATE]

This command causes the trigger system to initiate. This command completes one full trigger cycle when the trigger source is an immediate and initiates the trigger subsystem when the trigger source is bus.

TRIGger[:SEQuence]:DELay{<seconds>| MINimum | MAXimum}

This command sets the time delay between the detection of an event on the specified trigger source and the start of any corresponding trigger action on the power supply output. Select from 0 to 3600 seconds. MIN = 0 seconds.

MAX = 3600 seconds. At *RST , this value is set to 0 seconds.

TRIGger[:SEQuence]:DELay?

This command queries the trigger delay.

TRIGger[:SEQuence]:SOURce {BUS | IMMEDIATE}

This command selects the source from which the power supply will accept a trigger. The power supply will accept a bus (software) trigger or an internal immediate trigger. At *RST, the bus trigger source is selected.

TRIGger[:SEQuence]:SOURce?

This command queries the present trigger source. Returns "BUS" or "IMM"

***TRG**

This command generates a trigger to the trigger subsystem that has selected a bus (software) trigger as its source. The command has the same effect as the Group Execute Trigger (GET) command.

System-Related Commands

DISPlay[:WINDow][:STATe] {OFF | ON}

This command turns the front-panel display off or on. When the display is turned off, outputs are not sent to the display and all annunciators are disabled except the "ERROR" and "Rmt" annunciators.

The display state is automatically turned on when you return to the local mode. When you press the "Local" key to return to the local state from the remote interface, then press any key or "power-on/reset" key except for the number keys, knobs, "Resolution" "Clear", "Enter", and "Track" keys, to make the display state turned on automatically.

DISPlay[:WINDow][:STATe]?

This command queries the front-panel display setting. Returns “0” (OFF) or “1” (ON).

DISPlay[:WINDow]:TEXT[:DATA] <quoted string>

This command displays a message on the front panel. The power supply will display up to 12 characters in a message in the form of English letters, Arabic numerals and the blank spaces. Any additional characters are truncated. All the appeared special marks are displayed in the form of the blank spaces with individual display space respectively. (Except for the single quotes, because which indicate the start and the end of the charater string message.) The power supply will not send the output to the display when a message is shown on the front panel.

DISPlay[:WINDow]:TEXT[:DATA]?

This command queries the message sent to the front panel and returns a quoted string.

DISPlay[:WINDow]:TEXT:CLEar

This command clears the message displayed on the front panel, and makes the display exit the charater string displaying mode to switch to the immediate mode automatically.

SYSTem:BEEPer[:IMMediate]

This command make the power supply generates a single beep immediately.

SYSTem:ERRor?

This command queries the power supply's error queue. When the front-panel “ERROR” annunciator turns on, one or more command syntax or hardware errors have been detected. Up to 20 errors can be stored in the error queue.

SYSTem:VERSion?

This command queries the power supply to determine the present SCPI version. The returned value is of a string in the form YYYY.V where the “Y’s” represent the year of the version, and the “V” represents a version number for that year (for example, 1995.0).

***IDN?**

This query command reads the power supply's identification string. The power supply returns four fields separated by commas. The first field is the manufacturer's name, the second field is the model number, the third field is not used (always "0"), and the fourth field is a revision code which contains three numbers. The first number is the firmware revision number for the main power supply processor; the second is for the input/output processor; and the third is for the front-panel processor.

The command returns a string with the following format :

```
ARRAY,3631A,0,1.3-1.0-1.5
```

***RST**

This command resets the power supply to its power-on state as follows:

Command	State
CURR[:LEV][:IMM]	Output dependent value※
CURR[:LEV]:TRIG	Output dependent value※
DISP[:STAT]	ON
INST[:SEL]	P6V
INST:COUP	NONE
OUTP[:STAT]	OFF
OUTP:TRAC	OFF
TRIG:DEL	0
TRIG:SOUR	BUS
VOLT[:LEV][:IMM]	0
VOLT[:LEV]:TRIG	0



**** The reset operation sets the current of +6V output to 5 A and the current of +25V and -25V outputs to 1 A.***

***TST?**

This query performs a complete self-test of the power supply. Returns "0" if the self-test passes or "1" if it fails.

***SAV { 0| 2 ||9 }**

This command stores the present state of the power supply to the specified location in non-volatile memory, which can store 10 sets of operating states from 0 to 9. The state storage feature "remembers" the states or values of INST[:SEL]、VOLT[:IMM]、CURR[:IMM]、OUTP[:STAT]、OUTP:TRAC、TRIG:SOUR and TRIG: DEL.

***RCL { 0| 2 ||9 }**

This command recalls a previously stored state. To recall a stored state, you must use the same memory location used previously to store the state. When recall a stored state, you must use the same memory location used previously to store the state.

Calibration Commands

CALibration:COUNT?

This command queries the power supply to determine the number of times it has been calibrated.

CALibration:CURRent[:DATA] <numeric value>

This command can only be used after calibration is unsecured. It enters a current value of a selected output that you obtained by reading an external meter. You must first select a calibration level (CAL:CURR:LEV) for the value being entered. Two successive values (one for each end of the calibration range) must be selected and entered. The power supply then computes new calibration constants. These constants are then stored in non-volatile memory.

CALibration:CURRent:LEVel {MINimum | MAXimum}

Before using this command, you must select the output which is to be calibrated by using INSTRument command. This command can only be used after calibration is unsecured. It sets the power supply to a calibration point that is entered with CALibration:CURRent[:DATA] command.

During calibration, two points must be entered and the low-end point (MIN) must be selected and entered first.

CALibration:SECure:CODE <new code>

This command enters a new security code. To change the security code, first unsecure the power supply using the old security code. Then, enter the new code.

CALibration:SECure:STATe {OFF | ON>}, <code>

This command unsecures or secures the power supply for calibration.

CALibration:SECure:STATe?

This command queries the secured state for calibration of the power supply.

The returned parameter is "0" (unsecured) or "1" (secured).

CALibration:STRing <quoted string>

This command records calibration information about your power supply.

For example, you can store such information as the calibrator, or the calibration date etc.

CALibration:STRing?

This command queries the calibration message and returns a quoted string.

CALibration:VOLTage[:DATA] <numeric value>

This command can only be used after calibration is unsecured. It enters a voltage value of a selected output that you obtained by reading an external meter. You must first select a calibration level (CAL:VOLT:LEV) for the value being entered. Two successive values (one for each end of the calibration range) must be selected and entered. The power supply then computes new voltage calibration constants. These constants are then stored in internal memory.

CALibration:VOLTage:LEVel {MINimum | MAXimum}

Before using this command, you must select the output which is to be calibrated by using INSTRument command. This command can only be used after calibration is unsecured. It sets the power supply to a calibration point that is entered with CALibration:VOLTage[:DATA] command. During calibration, two points must be entered and the low-end point (MIN) must be selected

RS-232 Interface Commands

SYSTem:LOCal

This command places the power supply in the local mode during RS-232 operation. All keys on the front panel are fully functional. The “Rmt” annunciator on the display is off.

SYSTem:REMOte

This command places the power supply in the remote mode for RS-232 operation. All keys on the front panel, except the “Local” key, are disabled. The “Rmt” annunciator on the display is on.

SYSTem:RWLock

This command places the power supply in the remote mode for RS-232 operation. All keys on the front panel, including the “Local” key, are disabled. The “Rmt” annunciator on the display is on.

Ctrl-C

This command clears the operation in progress over the RS-232 interface and discards any pending output data.

The SCPI Status Registers

All SCPI instruments implement status registers in the same way. The status system records various instrument conditions in three register groups: the Status Byte register, the Standard Event register, and the Questionable Status register group. The status byte register records high-level summary information reported in the other register groups. The chapter five will illustrate the SCPI status system used by the power supply.

What is an Event Register?

An event register is a read-only register that reports defined conditions within the power supply. Bits in an event register are latched. Once an event bit is set, subsequent state changes are ignored. Bits in an event register are automatically cleared by a query of that register (such as *ESR? Or STAT:QUES:EVEN?) or by sending the *CLS (clear status) command. A reset (*RST) or device clear will not clear bits in event registers. Querying an event register returns a decimal value which corresponds to the binary-weighted sum of all bits set in the register.

What is an Enable Register?

An enable register defines which bits in the corresponding event register are logically ORed together to form a single summary bit. Enable registers are both readable and writable. Querying an enable register will not clear it. The *CLS (clear status) command does not clear enable registers but it does clear the bits in the event registers. To enable bits in an enable register, you must write a decimal value which corresponds to the binary-weighted sum of the bits you wish to enable in the register.

What is a Multiple Logical Output?

The three-logical outputs of the power supply include an INSTRument summary status register and an individual instrument ISUMmary register for each logical output. The ISUMmary registers report to the INSTRument register, which in turn reports to bit 13 of the Questionable status register. This is shown pictorially on the next page.

Using such a status register configuration allows a status event to be cross-referenced by output and type of event. The INSTRument register indicates which output(s) have generated an event. The ISUMmary register is a pseudoquestionable status register for a particular logical output.

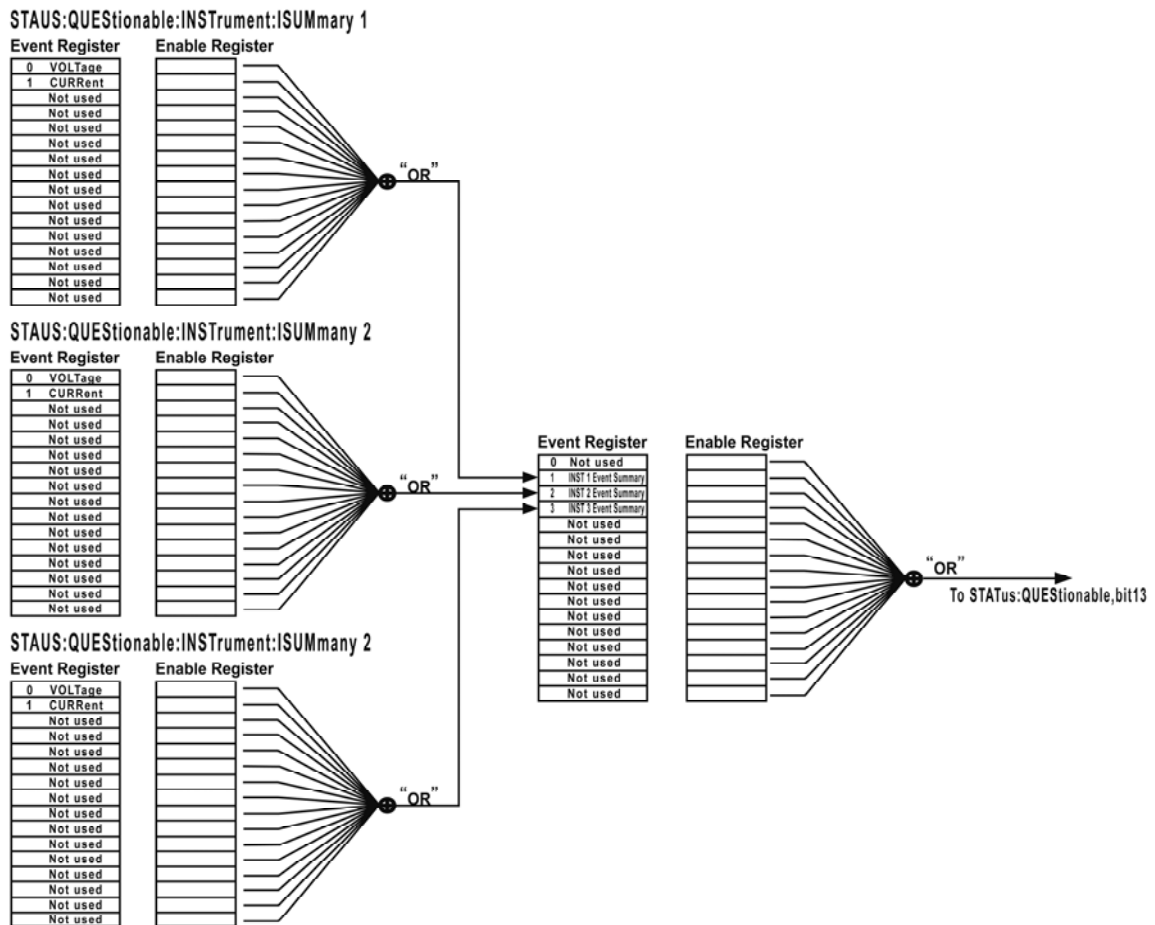

The Questionable Status Register

The Questionable Status register provides information about unexpected operation of the power supply. Bit 4 reports a fault with the fan, and bit 13 summarizes questionable outputs for any of the three supplies. For example if one of the three supplies is in constant voltage mode and due to an overload loses regulation, bit 13 is set (latched). Send the command STAT:QUES? to read the register. To make use of bit 13 you must first enable registers you wish to summarize with bit 13. Send STAT:QUES :INST:ENAB 14 to enable the Questionable Instrument register. Then send STAT:QUES:INST:ISUM<n>:ENAB 3 for each supply to enable the Questionable Instrument Summary register, where N is 1, 2, or 3.

Bit Definitions - Questionable Status Register

Bit	Decimal Value	Definition
0-3(Not used)	0	Always set to 0
4(Fan)	16	The fan has a fault condition.
5-12(Not used)	0	Always set to 0
13(ISUM)	8192	Summary of QUES:INST and QUES:INST:ISUM registers.
14-15(Not used)	0	Always set to 0

The Questionable Instrument Status Register

The Questionable Instrument register provides information about unexpected operations for each of the three supplies. For example if the +6V supply is in the constant voltage mode and loses regulation, then bit 1 set indicating a possible overload in the +6V supply. The +25V supply is reported as bit 2, and the -25V supply as bit 3. Send the command STAT QUES:INST? to read the register. The STAT:QUES:INST:ISUM<n> registers must be enabled to

make use of the Questionable Instrument register. Send STAT:QUES:INST:ISUM<n>:ENAB 3 to enable output n.

The Questionable

Are three Questionable Instrument Summary registers, one for each supply output. These registers provide information about voltage and current regulation. Bit 0 is set when the voltage becomes unregulated, and bit 1 is set if the current becomes unregulated. For example if a supply which is operating as a voltage source (constant voltage mode) momentarily goes to constant current mode, bit 0 is set to indicate that the voltage output is not regulated. To read the register for each supply, send

STAT:QUES :INST:ISUM<n>?, where n is 1, 2, or 3. To determine the operating mode (CV or CC) for the power supply send STAT:QUES:INST:ISUM<n>:COND?, where n is 1, 2, or 3 depending on the output. Bit 1 true indicates the output is in constant voltage mode, bit 0 true indicates constant current mode, both bits true indicates neither the voltage nor the current is regulated, and both bits false indicates the outputs of the power supply are off.

The Questionable Status Event register is cleared when:

1. You execute the *CLS (clear status) command.
2. You query the event register using STATus:QUESTionable [:EVENT]? (Status Questionable Event register) command.

The Questionable Status Enable register is cleared when:

You execute STATus:QUESTionable:ENABle 0 command. For example, you must send the STAT:QUES:ENAB 16 to enable the FAN bit.

The Standard Event Register

The Standard Event register reports the following types of instrument events: power-on detected, command syntax errors, command execution errors, self-test or calibration errors, query errors, or when an *OPC command is executed. Any or all of these conditions can be reported in the Standard Event Summary bit (ESB, bit 5) of Status Byte register through the

enable register. To set the enable register mask, you write a decimal value to the register using the *ESE (Event Status Enable) command.

Bit Definitions - Standard Event Register

Bit	Decimal Value	Definition
0 OPC	1	Operation Complete. All commands prior to and including an *OPC command have been executed.
1 not used	0	Always set to 0.
2 QYE	4	Query Error. The power supply tried to read the output buffer but it was empty. Or, new command line was received before a previous query had been read. Or, both the input and output buffers are full.
3 DDE	8	Device Error. A self-test or calibration error occurred
4 EXE	16	Execution Error. An execution error occurred
5 CME	32	Command Error. A command syntax error occurred
6 not used	0	Always set to 0.
7 PON	128	Power On. Power has been turned off and on since the last time the event register was read or cleared

The Standard Event register is cleared when:

1. You execute the *CLS (clear status) command.
2. You query the event register using the *ESR? (Event Status register) command.

For example, 28 (4 + 8 + 16) is returned when you have queried the status of the Standard Event register, QYE, DDE, and EXE conditions have occurred.

The Standard Event Enable register is cleared when:

1. You execute the *ESE 0 command.
2. You turn on the power and have previously configured the power supply using the *PSC 1 command.
3. The enable register will not be cleared at power-on if you have previously configured the power supply using the *PSC 0 command.

For example, you must send the *ESE 24 (8 + 16) to enable DDE and EXE bits.

The Status Byte Register

The Status Byte summary register reports conditions from the other status registers. Query data that is waiting in the power supply's output buffer is immediately reported through the "Message Available" bit (bit 4) of Status Byte register. Bits in the summary register are not latched. Clearing an event register will clear the corresponding bits in the Status Byte summary register. Reading all messages in the output buffer, including any pending queries, will clear the message available bit.

Bit Definitions - Status Byte Summary Register

Bit	Decimal Value	Definition
0-2 not used	0	Always set to 0
3 QUES	8	One or more bits are set in the questionable status register (bits must be "enabled" in the enable register).
4 MAV	16	Data is available in the power supply output buffer.
5 ESB	32	One or more bits are set in the standard event register (bits must be "enabled" in the enable register).
6 RQS	64	The power supply is requesting service (serial poll).
7 not used	0	Always set to 0

The Status Byte Summary register is cleared when:

1. You execute the *CLS (clear status) command.
2. Querying the Standard Event register (*ESR? command) will clear only bit 5 in the Status Byte summary register. For example, 24 (8 + 16) is returned when you have queried the status of the Status Byte register, QUES and MAV conditions have occurred.

The Status Byte Enable register (Request Service) is cleared when:

1. You execute the *SRE 0 command.
2. You turn on the power and have previously configured the power supply using the *PSC 1 command.
3. The enable register will not be cleared at power-on if you have previously configured the power supply using *PSC 0. For example, you must send the *SRE 96 (32 + 64) to enable ESB and RQS bits.

Status Reporting Commands

SYSTem:ERRor?

This query command reads one error from the error queue.

When the front-panel ERROR annunciator turns on, one or more command syntax or hardware errors have been detected. A record of up to 20 errors can be stored in the power supply's error queue. The exceeded error will not be restored.

1. Errors are retrieved in first-in-first-out (FIFO) order. The first error returned is the first error that was stored. When you have read all errors from the queue, the ERROR annunciator turns off.
2. If more than 20 errors have occurred, the last error stored in the queue (the most recent error) is replaced with -350, "Too many errors". No additional errors are stored until you remove errors from the queue. If no errors have occurred when you read the error queue, the power supply responds with "+0", "No error".
3. The error queue is cleared when power has been off or after a *CLS (clear status) command has been executed. The *RST (reset) command does not clear the error queue.

STATus:QUESTionable[:EVENT]?

This command queries the Questionable Status event register. The power supply returns a decimal value which corresponds to the binary-weighted sum of all bits in the register.

STATus:QUESTionable:ENABLE <enable value>

This command enables bits in the Questionable Status enable register. The selected bits are then reported to the Status Byte.

STATus:QUESTionable:ENABLE?

This command queries the Questionable Status enable register. The power supply returns a binary-weighted decimal representing the bits set in the enable register.

STATus:QUESTIONable:INSTrument[:EVENT]?

This command queries the Questionable Instrument event register. The power supply returns a decimal value which corresponds to the binary-weighted sum of all bits in the register and clears the register.

STATus:QUESTIONable:INSTrument:ENABLE <enable value>

This command sets the value of the Questionable Instrument enable register. This register is a mask for enabling specific bits from the Questionable Instrument event register to set the Instrument Summary bit (ISUM, bit 13) of the Questionable Status register. The "ISUM" bit of the Questionable Status register is the logical OR of all the Questionable Instrument event register bits that are enabled by the Questionable Instrument enable register.

STATus:QUESTIONable:INSTrument:ENABLE?

This command queries the Questionable Instrument enable register.

STATus:QUESTIONable:INSTrument:ISUMmary<n>[:EVENT] ?

This query returns the value of the Questionable Instrument Isummary event register for a specific output of the three-output power supply. The particular output must be specified by a numeric value, in which "n" is 1,2, or 3. The event register is a read-only register which holds/latches all events. Reading the Questionable Instrument Isummary event register clears it.

STATus:QUESTIONable:INSTrument:ISUMmary<n>:CONDit ion?

This query returns the CV or CC condition of the specified instrument. If "2" is returned, the queried instrument is in the CV operating mode. If "1" is returned, the queried instrument is in the CC operating mode. If "0" is returned, the queried instrument is neither in the CV operating mode nor in the CC operating mode. If "{FMC_quoteleft}3" is returned, the instrument is in the hardware failure.

STATus:QUESTIONable:INSTrument:ISUMmary<n>:ENABLE <enable value>

This command sets the value of the Questionable Instrument

Isummary enable register for a specific output of the three-output power supply. The particular output must be specified by a numeric value. n is 1, 2, or 3. This register is a mask for enabling specific bits from the Questionable Instrument Isummary event register to set the Instrument

Summary bit (bit 1, 2, and 3) of the Questionable Instrument register. These bits 1, 2, and bit 3 are the logical OR of all the Questionable Instrument Isummary event register bits that are enabled by the Questionable Instrument Isummary enable register.

STATUS:QUESTIONABLE:INSTRUMENT:ISUMMARY<n>:ENABLE?

This query returns the value of the Questionable Instrument Isummary enable register. n is 1, 2, or 3.

***CLS**

This command clears all event registers and Status Byte register.

***ESE <enable value>**

This command enables bits in the Standard Event enable register. The selected bits are then reported to the Status Byte.

***ESE?**

This command queries the Standard Event enable register. The power supply returns a decimal value which corresponds to the binary-weighted sum of all bits in the register.

***ESR?**

This command queries the Standard event register. The power supply returns a decimal value which corresponds to the binary-weighted sum of all bits in the register.

***OPC**

This command sets the "Operation Complete" bit (bit 0) of the Standard Event register after the command is executed.

***PSC { 0 | 1 }**

(Power-on status clear.) This command clears the Status Byte and the Standard Event register enable masks when power is

turned on (*PSC 1). When *PSC 0 is in effect, the Status Byte and Standard Event register enable masks are not cleared when power is turned on.

***PSC?**

This command queries the power-on status clear setting. The returned parameter is "0" (*PSC 0) or "1" (*PSC 1).

***SRE <enable value>**

This command enables bits in the Status Byte enable register.

***SRE?**

This command queries the Status Byte Enable register. The power supply returns a decimal value which corresponds to the binary-weighted sum of all bits set in the register.

***STB?**

This command queries the Status Byte summary register. The *STB? command is similar to a serial poll but it is processed like any other instrument command. The *STB? command returns the same result as a serial poll but the "Request Service" bit (bit 6) is not cleared if a serial poll has occurred.

***WAI**

This command instructs the power supply to wait for all pending operations to complete before executing any additional commands over the interface.
Used only in the triggered mode.

SCPI Conformance Information

The SCPI commands relevant to the power supply operation are introduced in detail in this manual, and most of their usage and formats are in accordance with the standard SCPI commands. There are still some commands required by the standard SCPI commands not being introduced but it is not necessary for the users to know them.

SCPI Confirmed Commands

The following commands are being introduced in this manual:

DISPlay

```
[ :WINDow ] [ :STATe ] { OFF | ON }  
[ :WINDow ] [ :STATe ] ?  
[ :WINDow ] :TEXT [ :DATA ] <quoted string>  
[ :WINDow ] :TEXT [ :DATA ] ?  
[ :WINDow ] :TEXT :CLEAr
```

INSTrument

```
[ :SELEct ] { P6V | P25V | N25V }  
[ :SELEct ]  
:NSELEct : { 1 | 2 | 3 }  
:NSELEct ?  
COUPLe [ :TRIGger ] { ALL | NONE } <list>  
COUPLe [ :TRIGger ] ?
```

MEASure

```
:CURRent [ :DC ] ?  
[ :VOLTage ] [ :DC ] ?
```

OUTPUT

```
[ :STATe ] { OFF | ON }  
[ :STATE ] ?
```

SOURce:]

```
CURRent [ :LEVe ] [ :IMMediate ] [ :AMPLitude ]  
{ <current> | MIN | MAX }  
CURRent [ :LEVe ] [ :IMMediate ] [ :AMPLitude ] ? [ MIN | MAX ]
```

```
CURRent [ :LEVe ] :TRIGgered [ AMPLitude ]  
{ <current> | MIN | MAX }
```

```
CURRent [ :LEVe ] :TRIGgered [ :AMPLitude ] ? [ MIN | MAX ]  
VOLTage [ :LEVe ] [ :IMMediate ] [ :AMPLitude ]  
{ <voltage> | MIN | MAX }
```

```
VOLTage [ :LEVe ] [ IMMediate ] [ :AMPLitude ] ? [ MIN : MAX ]  
VOLTage [ :LEVe ] :TRIGgered [ :AMPLitude ]  
{ <voltage> | MIN | MAX }
```

VOLTage[:LEVel]:TRIGgered[:AMPLitude]?[MIN|MAX]

STATus

```
:QUESTionable[:EVENT]?
:QUESTionable:ENABle <enable value>
:QUESTionable:ENABle?
:QUESTionable:INSTrument[:EVENT]?
:QUESTionable:INSTrument:ENABle <enable value>
:QUESTionable:INSTrument:ENABle?
:QUESTionable:INSTrument:ISUMary<n>[:EVENT]?
:QUESTionable:INSTrument:ISUMary<n>:CONDition?

:QUESTionable:INSTrument:ISUMary<n>:ENABle
<enable value>
:QUESTionable:INSTrument:ISUMary<n>:ENABle?
```

SYSTem

```
:BEEPer[:IMMEDIATE]
:ERRor?
:VERSion
```

TRIGger

```
[:SEQuence]:DELay {<second>|MIN|MAX}
[:SEQuence]:DELay?
[:SEQuence]:SOURce{BUS|IMM}
[:SEQuence]:SOURce?
```

```
INITiate[:IMMEDIATE]
```

Device Specific Commands

The following commands are device-specific to the ARRAY 3631A power supply.

However, these commands are designed with the SCPI standard in mind and they follow all of the command syntax rules defined by the standard.

List as follow:

APPLy

```
{P6V|P25V|N25V}{,<voltage>|DEF|MIN|MAX>}{,<current>|DEF|MIN|MAX}}
```

APPLy? [{P6V|P25V|N25}]

CALibration

:COUNT?
:CURRent[:DATA] <numeric value>
:CURRent:LEVel {MIN|MAX}
:SECure:CODE <new code>
:SECure:STATe {OFF|ON}, <voltage>
:SECure:STATe?
:STRing <quoted string>
:STRing?
:VOLTage[:DATA] <numeric value>
:VOLTage:LEVel {MIN|MAX}

MEASure

:CURRent [:DC]? [{P6V|P25V|N25V}]
[:VOLTage][:DC]? [{P6V|P25V|N25V}]

OUTPut

:TRACK[:STATe] {OFF|ON}
:TRACK[:STATe]?

[SOURce:]

CURRent[:LEVel]:LIMit[:AMPLitude]
{<current>|MIN|MAX|DEF}
CURRent[:LEVel]:LIMit[:AMPLitude]? {MIN|MAX|DEF}
VOLTage[:LEVel]:LIMit[:AMPLitude]
{<voltage>|MIN|MAX|DEF}
VOLTage[:LEVel]:LIMit[:AMPLitude]? {MIN|MAX|DEF}

SYSTem

:LOCal
:REMote
:RWLock

5

----- Application Programs

Application Programs

RS-232 operation using QuickBASIC

The following example shows how to send command instruction and receive command responses over the RS-232 interface using QuickBASIC. This program has been tested and can be used directly.

RS-232 operation using QuickBASIC

```
CLS'
LOCATE 1, 1
    ' Set the cursor at the first line of the first row

DIM Recv$(100)
    ' restore and receive the data array.

OPEN "COM1:9600, N, 8, 2, RS, LF, PE" FOR RANDOM AS
#1 LEN = 1000
    ' Baud Rate: 9600
    ' Parity Check: None
    ' Data Bit: 8
    ' Stop Bit: 2
    ' RS: sending RTS signal is forbidden
    ' LF: a <carriage return> followed by a <new line>
    automatically
    ' Visit: Random
    ' File number: 1
    ' #1 Length: 1000
```

PRINT #1, "SYST:REM"

' Put the power supply into the remote operation mode

PRINT #1, "OUTP ON"

' Enable the outputs

PRINT #1, "SYST:ERR?"

' Error message

LINE INPUT #1, Recv\$

' Receive the data from the power supply

PRINT "SYST:ERR? : ", Recv\$

' Print the received data on the display

6

----- Tutorial

Tutorial

The ARRAY 3631 is a high performance instrument capable of delivering clean dc power. But to take full advantage of the performance characteristics designed into the power supply, certain basic precautions must be observed when connecting it for use on the lab bench or as a controlled power supply. This chapter gives specific details on the operation and use of the ARRAY 3631 DC power supply:

Overview of ARRAY 3631 Operation

The ARRAY 3631A has a very precise regulating properties and respond quickly to variations of the line and load. These supplies also exhibit low ripple and noise, the tolerance of ambient temperature changes, their circuit simplicity, and a high reliability.

The ARRAY 3631A contains three linear regulated power supplies. Each is controlled by a control circuit that provides voltages to program the outputs. Each supply sends back to the control circuit voltages representing outputs at the terminals. The control circuits receive information from the front panel and send information to the display. At the same time, the control circuits also receive and return the corresponding values over the remote interface.

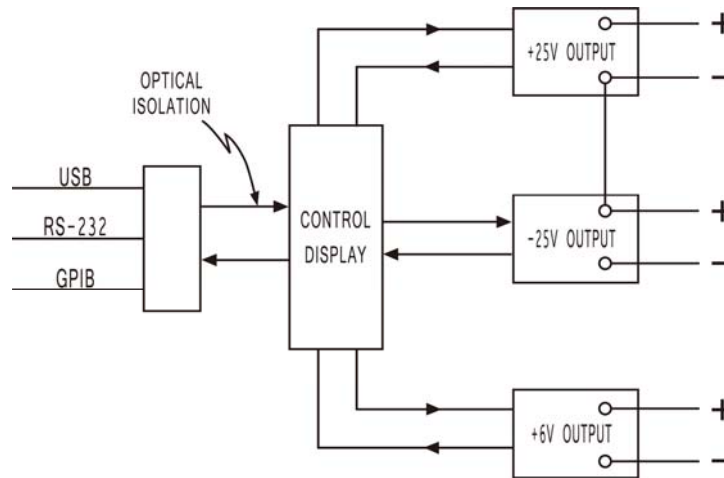

The $\pm 25\text{V}$ power supplies share a common ground in the circuit. The remote interface is isolated from the control circuit and the the $\pm 25\text{V}$ supplies. The $+6\text{V}$ supply is also isolated from the remote interface and the $\pm 25\text{V}$ supplies.

Output Characteristics

An ideal constant-voltage power supply would have a zero output impedance at all frequencies. Thus, the voltage would remain perfectly constant in spite of any changes in output current demanded by the load. The ideal constant-current power supply exhibits an infinite output impedance at all frequencies. Thus the output voltage of the ideal constant-current power supply would change correspondingly when a load change occurred in order to maintain its output current at a constant value.

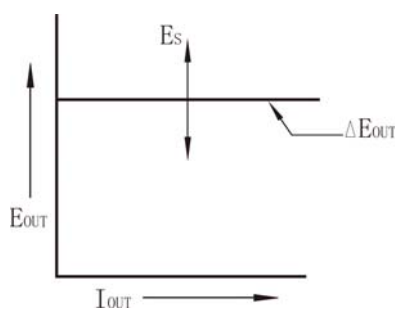

Ideal Constant Voltage Mode

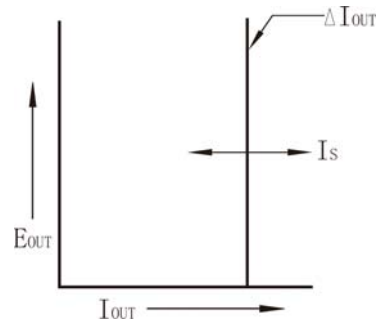

Ideal Constant Current Mode

Each of the three ARRAY 3631A power supply outputs can operate in either constant-voltage (CV) mode or constant-current (CC) mode. Under certain fault conditions, the power supply can not operate in either CV or CC mode and becomes unregulated.

Figure below shows the operating modes of the three outputs of the ARRAY 3631 power supply. The operating point of one supply will be either above or below the line $R_L = R_C$. This line represents a load where the output voltage and the output current are equal to the voltage and current setting. When the load R_L is greater than R_C , the output voltage will dominate since the current will be less than the current setting. The power supply is said to be in constant-voltage mode. The load at point A has a relatively high resistance value (compared to R_C), the output voltage is at the voltage setting, and the output current is less than the current setting. In this case the power supply is in the constant-voltage (CV) mode and the current setting acts as a current limit.

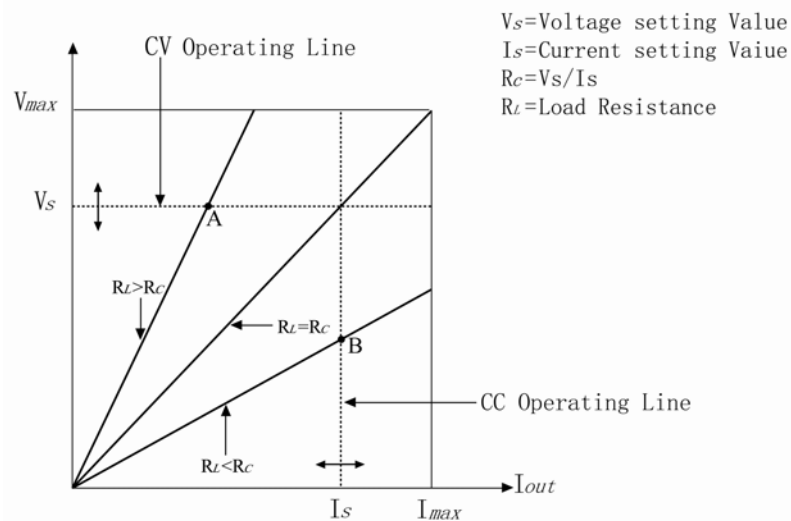

When the load R_L is less than R_C , the output current will dominate since the voltage will be less than the set voltage. The power supply is said to be in constant-current mode. The load at point B has a relatively low resistance, the output voltage is less than the voltage setting, the output current is at the current setting. The supply is in constant-current (CC) mode and the voltage setting acts as a voltage limit.

Unregulated State

If the power supply should go into a mode of operation that is neither CV nor CC, the power supply is in unregulated mode, which may occur momentarily. In this mode the output is not predictable. The unregulated condition may be the result of the ac line voltage below the specifications or caused by non-resistive load. For example when the output is programmed for a large voltage step; the output capacitor or a large capacitive load will charge up at the current limit setting. During the ramp up of the output voltage the power supply will be in the unregulated mode. During the transition from CV to CC as when the output is shorted, the unregulated state may occur briefly during the transition.

Unwanted Signals

An ideal power supply has a perfect dc output with no signals across the terminals or from the terminals to earth ground. The actual power supply has finite noise across the output terminals, and a finite current will flow through any impedance connected from either terminal to earth ground. Both of these are of very low value in the ARRAY 3631A.

The noise across from the terminals to earth ground can be a problem for very sensitive circuitry that is referenced to earth ground. When a circuit is referenced to earth ground, a low level line--related ac current will flow from the output terminals to earth ground. Any impedance to earth ground will create a voltage drop equal to the current flow multiplied by the impedance. To minimize this effect, the output terminal can be grounded at the output terminal. Alternately, any impedances to earth ground should have a complementary impedance to earth ground to cancel any generated voltages.

Connecting the Load

Output Isolation

The outputs of all three power supplies are isolated from earth

ground. Any output terminal may be grounded, or an external voltage source may be connected between any terminal output and ground. However, output terminals must be kept within ± 240 Vdc of ground. The ± 25 V supplies are tied together at one common terminal. Any one of the three terminals can be tied to ground as needed. An earth ground terminal is provided on the front panel for convenience.

Multiple Loads

When connecting multiple loads to the power supply, each load should be connected to the output terminals using separate connecting wires. This minimizes mutual coupling effects between loads and takes full advantage of the low output impedance of the power supply. Each pair of wires should be as short as possible and twisted or shielded to reduce lead inductance and noise pick-up. If a shield is used, connect one end to the power supply ground terminal and leave the other end disconnected.

If cabling considerations require the use of distribution terminals that are located remotely from the power supply, connect output terminals to the distribution terminals by a pair of twisted or shielded wires. Connect each load to the distribution terminals separately.



**** To satisfy safety requirements, load wires must be heavy enough not to overheat while carrying the short-circuit output current of the power supply.***

Considerations

When using the power supply, various problems may occur because of the difference of connected loads, which will be introduced as follow respectively.

Capacitive Loading

In most cases, the power supply will be stable for almost any size load capacitance. Large load capacitors may cause ringing in the power supply's transient response. It is possible that certain combinations of load capacitance, equivalent series resistance, and load lead inductance will result in instability. If this occurs, the problem may often be solved by either increasing or decreasing the total load capacitance.

A large load capacitor may cause the power supply to cross into CC or unregulated mode momentarily when the output voltage is reprogrammed.

The slew rate of the output voltage will be limited to the current setting divided by the total load capacitance (internal and external).

AWG	Internal Capacitance	External Bleed Resistor	Slew Rate at No Load and Full Scale Current Setting
+6VOutput	1000uF	390Ω	8 V/msec
+25VOutput	470uF	5000Ω	1.5 V/msec
-25VOutput	470uF	5000Ω	1.5 V/msec

Inductive loading

Inductive loads present no loop stability problems in constant voltage mode. In constant current mode, inductive loads form a parallel resonance with the power supply's output capacitor. Generally this will not affect the stability of the power supply, but it may cause ringing of the current in the load.

Pulse Loading

In some applications the load current varies periodically from a minimum to a maximum value. The constant current circuit limits the output current. Some peak loading exceeding the current limit can be obtained due to the output capacitor. To stay within the specifications for the output, the current limit should be set greater than the peak current expected or the supply may go into CC mode or unregulated mode for brief periods.

Reverse Current Loading

An external source can not be allowed to pump current into the supply without risking loss of regulation and possible damage.

Extending the output

The ARRAY 3631A provides +6V/5A, +25V/1A and –25V/1A outputs, and different connections enable the power supply to provide voltages or currents greater than its rated maximum outputs.

Series operation of two or more power supplies can obtain a higher voltage output than that available from a single supply. Series connected power supplies can be operated with one load across both power supplies or with a separate load for each power supply. The power supply has a related internal protection function so that if operated in series with other power supplies, damage will not occur if the load is short-circuited or if one power supply is turned on separately from its series partners.

In the ARRAY 3631A the +25V and –25V supplies can be operated in series to obtain one 0-50V supply. The power supply can be put in “Track” mode and then the voltage output will be twice that of either the +25V supply or the -25V supply shown on the front panel. The current will be the same value shown on the front panel.

Reliability

Reliability of the power supply depends heavily on the ambient condition, in which the humidity and temperature will affect the reliability. The lower the temperature of the components, the better the reliability. When the power supply is used, an internal fan installed in the rear of power supply can keep the temperature of components low. To assist in cooling the ARRAY 3631A the sides and rear of the ARRAY 3631A should be kept clear.

7

----- Specifications

Specifications

The performance specifications of ARRAY 3631A are listed in the following pages.

(Specifications are warranted in the temperature range of 0 to 40 °C with a resistive load.) Please consult the relevant data when in actual use

Performance Specifications

Output Ratings

	+6V	+25V	-25V
Voltage	0~6V	0~25V	0~-25V
Current	0~5A	0~1A	0~1A

Ripple and Noise (20 Hz to 20 MHz)

	+6V	+25V	-25V
Voltage	<0.35mVrms	<0.35mVrms	<0.35mVrms
	<2mVp-p	<2mVp_p	<2mVp-p
Current	<2mArms	500uArms	500uArms

Common mode current

1.5uArms

Load Regulation

Voltage	<0.01%+2mV
Current	<0.01%+250uA

Line Regulation

Voltage	<0.01%+2mV
Current	<0.01%+250uA

Programming Accuracy

	+6V	+25V	-25V
Voltage	0.1%+5mV	0.05%+20mV	0.05%+20mV
Current	0.2%+10mA	0.15%+4mA	0.15%+4mA

Readback Accuracy

	+6V	+25V	-25V
Voltage	0.1%+5mV	0.05%+10mV	0.05%+10mV
Current	0.2%+10mA	0.15%+4mA	0.15%+4mA

Programming Resolution

	+6V	+25V	-25V
Voltage	0.5mV	1mV	1mV
Current	0.5mA	0.1mA	0.1mA

Readback Resolution

	+6V	+25V	-25V
Voltage	0.5mV	1mV	1mV
Current	0.5mA	0.1mA	0.1mA

Meter Resolution

	+6V	+25V	-25V
Voltage	1mV	10mV	10mV
Current	1mA	1mA	1mA

Transient Response Time

Less than 50us for output recover to within 15 mV following a change in output current from full load to half load or vice versa

Command Processing Time

Programming Commands : Maximum time for output to change after receipt of APPLy and SOURce commands) : <50 msec

Readback Command : Maximum time to readback output by MEASure? command : <100 msec

The Other Commands : < 50 msec

Tracking Accuracy

The $\pm 25V$ outputs track each other within $\pm(0.2\%$ of output + 20 mV).

Supplemental Characteristics

Output Programming Range (maximum programmable values)

	+6V Output	+25V Output	-25V Output
Voltage	0~6.2 V	0~26 V	0~-26 V
Current	0~5.2A	0~1.1 A	0~1.1 A

Temperature Coefficient, \pm (% of output + offset)

Maximum change in output/readback per °C after a 30-minute warm-up

	+6V Output	+25V Output	-25V Output
Voltage	0.01% + 2 mV	0.01% + 3 mV	0.01% + 3 mV
Current	0.02% + 3 mA	0.02% + 0.5 mA	0.02% + 0.5 mA

Stability, \pm (% of output + offset)

Following a 30-minute warm-up, change in output over 8 hours under constant load, line, and ambient temperature

	+6V Output	+25V Output	-25V Output
Voltage	0.03% + 1 mV	0.02% + 2 mV	0.02% + 2 mV
Current	0.1% + 3 mA	0.05% + 1 mA	0.05% + 1 mA

Voltage Programming Speed

Maximum time required for output voltage to settle within 1% of its total excursion

(for resistive load). Excludes command processing time.

	+6V Output	+25V Output	-25V Output
Full load Up	11 msec	50 msec	50 msec
Full load Down	13 msec	45 msec	45 msec
No load Up	10 msec	20 msec	20 msec
No load Down	200 msec	400 msec	400 msec

AC Input Ratings

110V/220V AC \pm 10% 47Hz~63Hz 350VA Max

Operating Temperature

0~55°C 0~80%RH

Cooling

Fan cooled

Output Voltage Overshoot

Less than 1V

Programming Language

SCPI (Standard Commands for Programmable Instruments)

Recommended Calibration Interval

1 year

Net weight

8.2 kg

Dimensions

212.6mm (W) × 132.6mm (H)
× 360mm (D) (8.4×5.2×14.2 in)

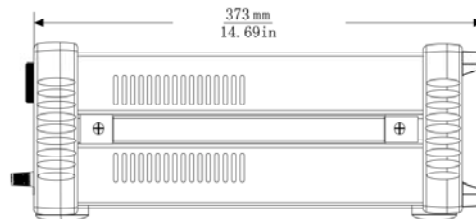
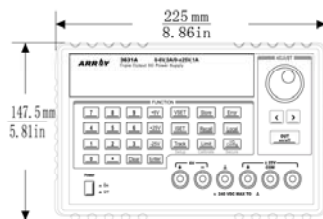
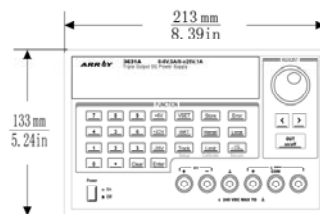

APPENDIX

----- **Error Messages**

Error Messages

When the front-panel ERROR annunciator turns on, and the power supply generates a short beep, one or more command syntax or hardware errors have been detected. A record of up to 20 errors is stored in the power supply's error queue.

Errors are retrieved in first-in-first-out (FIFO) order. The first error returned is the first error that was stored. When you have read all errors from the queue, the ERROR annunciator turns off automatically.

If more than 20 errors have occurred, the last error stored in the queue (the most recent error) is replaced with -350, "Too many errors". No additional errors are stored until you remove errors from the queue. If no errors have occurred when you read the error queue, the supply responds with + 0, "No error".

The error queue is cleared when power has been off or after a *CLS (clear status) command has been executed. The *RST (reset) command does not clear the error queue.

Front-panel operation:

If the ERROR annunciator is on, press the "Error" key repeatedly to read the errors stored in the queue. The error queue is cleared when you read all errors and the "ERROR" annunciator turns off.

Remote interface operation:

SYSTEM:ERROR? Reads one error from the error queue

Execution Errors

Code	Explanation
-101	<p>Invalid character</p> <p>An invalid character was found in the command string. You may have inserted a character such as #, \$, or % in the command keyword or within a parameter.</p> <p>Example: OUTP:TRAC #ON</p>
-102	<p>Syntax error</p> <p>Invalid syntax was found in the command string. You may have inserted a blank space before or after a colon in the command header, or before a comma.</p> <p>Example: VOLT:LEV ,1</p>
-103	<p>Invalid separator</p> <p>An invalid separator was found in the command string. You may have used a comma instead of a colon, semicolon, or blank space - or you may have used a blank space instead of a comma.</p> <p>Example: TRIG:SOUR,BUS or APPL P6V 1.0 1.0</p>
-104	<p>Data type error</p> <p>The wrong parameter type was found in the command string. You may have specified a number where a string was expected, or vice versa.</p>
-108	<p>Parameter not allowed</p> <p>More parameters were received than expected for the command. You may have entered an extra parameter, or you added a parameter to a command that does not accept a parameter.</p> <p>Example: APPL? 10</p>
-109	<p>Missing parameter</p> <p>Fewer parameters were received than expected for the command. You omitted one or more parameters that are required for this command.</p> <p>Example: APPL</p>

- 112 **Program mnemonic too long**
A command header was received which contained more than the maximum 12 characters allowed.

- 113 **Undefined header**
A command was received that is not valid for this power supply. You may have misspelled the command or it may not be a valid command. If you are using the short form of the command, remember that it may contain up to four letters.
Example: TRIGG:DEL 3

- 123 **Numeric overflow**
A numeric parameter was found whose exponent was larger than 32,000.

- 124 **Too many digits**
A numeric parameter was found whose mantissa contained more than 255 digits, excluding leading zeros.

- 131 **Invalid suffix**
A suffix was incorrectly specified for a numeric parameter. You may have misspelled the suffix.
Example: TRIG:DEL 0.5 SECS

- 134 **Suffix too long**
A suffix for a numeric parameter contained too many characters.

- 138 **Suffix not allowed**
A suffix was received following a numeric parameter which does not accept a suffix.
Example: STAT:QUES:ENAB 18 SEC (SEC is not a valid suffix).

- 144 **Character data too long**
The character data element contained too many characters.

- 151 **Invalid string data**
An invalid character string was received. Check to see

if you have enclosed the character string in single or double quotes.

Example: DISP:TEXT 'ON

- 211 **Trigger ignored**
A Group Execute Trigger (GET) or *TRG was received but the trigger was ignored. Make sure that the trigger source should be selected to the bus and the trigger subsystem should be initiated by INIT[:IMM] command.
- 213 **Init ignored**
A Group of INIT[:IMM] was received when the line is selected as the trigger source. Make sure that the trigger source should be selected to the bus and the trigger subsystem should be initiated by INIT[:IMM] command, then triggered by *TRG.
- 222 **Data out of range**
A numeric parameter value is outside the valid range for the command.
Example: TRIG:DEL -3
- 223 **Too much data**
A character string was received but could not be executed because the string length was more than 40 characters. This error can be generated by the CALibration:STRing command.
- 224 **Illegal parameter value**
A discrete parameter was received which was not a valid choice for the command. You may have used an invalid parameter choice.
Example: DISP:STAT XYZ (XYZ is not a valid choice).
- 350 **Too many errors**
The error queue is full because more than 20 errors have occurred. No additional errors are stored until you remove errors from the queue. The error queue is cleared when power has been off, or after a *CLS (clear status) command has been executed.

- 410 **Query INTERRUPTED**
A command was received which sends data to the output buffer, but the output buffer contained data from a previous command (the previous data is not overwritten). The output buffer is cleared when power has been off, or after a *RST (reset) command has been executed.
- 420 **Query UNTERMINATED**
The power supply was addressed to talk (i.e., to send data over the interface) but a command has not been received which sends data to the output buffer. For example, you may have executed an APPLY command (which does not generate data) and then attempted an ENTER statement to read data from the remote interface.
- 430 **Query DEADLOCKED**
A command was received which generates too much data to fit in the output buffer and the input buffer is also full. Command execution continues but all data is lost.
- 501 **Isolator UART framing error**
- 502 **Isolator UART overrun error**
- 511 **RS-232 framing error**
- 512 **RS-232 overrun error**
- 513 **RS-232 parity error**
- 521 **Input buffer overflow**
- 522 **Output buffer overflow**
- 800 **P25V and N25V coupled by track system**
The OUTP:TRAC should be off when coupling between the +25V output and the -25V output.

- 801 **P25V and N25V coupled by trigger subsystem**
The +25V output and the -25V output should be uncoupled to enable the tracking operation for those outputs.

Self-Test Errors

Code	Explanation
601	Front panel does not respond
603	System ADC test failed
607	Rundown too noisy
630	Fan test failed
631	System DAC test failed
632	P6V hardware test failed
633	P6V hardware test failed
634	P6V hardware test failed

Calibration Errors

Code	Explanation
702	Cal secured The calibration is secured.
703	Invalid secure code An invalid calibration security code was received when attempting to unsecure or secure the power supply. You must use the same security code to unsecure the power supply as was used to secure it, and vice versa.

The security code may contain up to 12 alphanumeric characters.

- 704 **Secure code too long**
A security code was received which contained more than 12 characters.

- 740 **Cal checksum failed, secure state**
- 741 **Cal checksum failed, string data**
- 745 **Cal checksum failed, DAC cal constants**
- 746 **Cal checksum failed, readback cal constants**
- 747 **Cal checksum failed, GPIB address**
- 748 **Cal checksum failed, internal data**
- 750 **Cal checksum failed, store/recall data in location 0**
- 751 **Cal checksum failed, store/recall data in location 1**
- 752 **Cal checksum failed, store/recall data in location 2**
- 753 **Cal checksum failed, store/recall data in location 3**
- 754 **Cal checksum failed, store/recall data in location 4**
- 755 **Cal checksum failed, store/recall data in location 5**
- 756 **Cal checksum failed, store/recall data in location 6**
- 757 **Cal checksum failed, store/recall data in location 7**
- 758 **Cal checksum failed, store/recall data in location 8**
- 759 **Cal checksum failed, store/recall data in location 9**

- +760 **Temperature too low**

- +761 **Temperature too High**

